

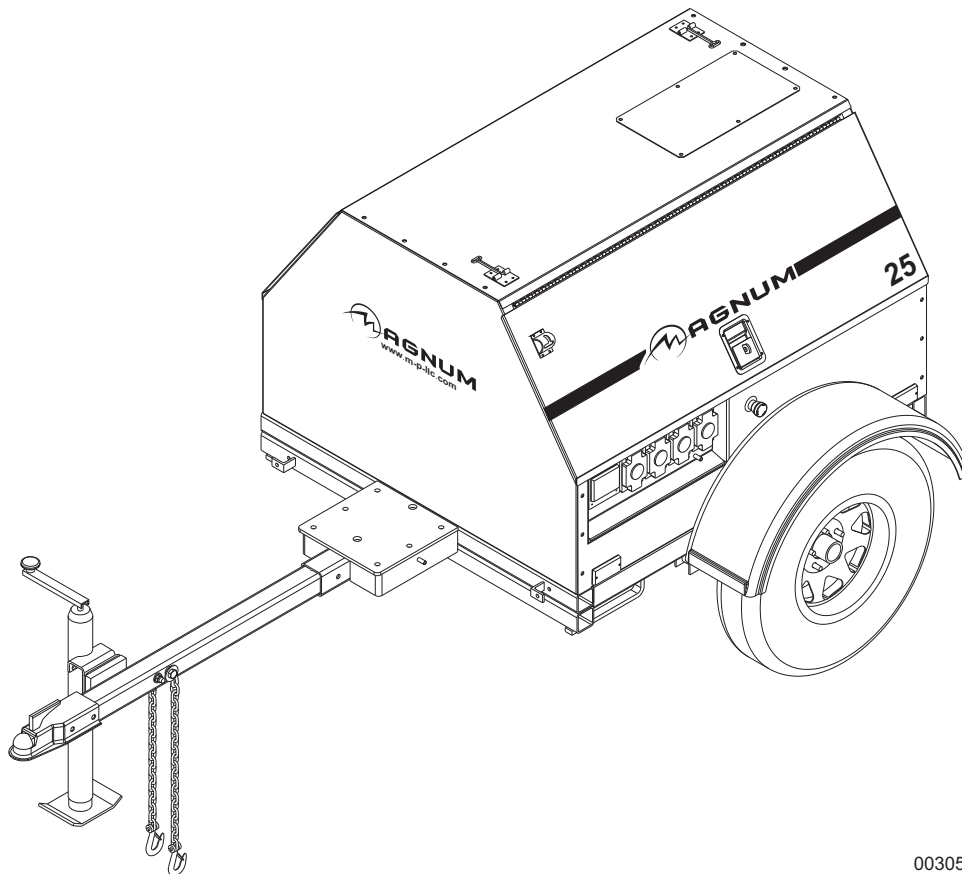

DIESEL GENERATOR MLG25 • MLG25CAN



00305

OPERATING MANUAL

Parts manuals available online! www.m-p-llc.com

INTRODUCTION

This manual provides information and procedures to safely operate and maintain the engine and generator. For your own safety and protection from physical injury, carefully read, understand, and observe the safety instructions described in this manual. *The information contained in this manual was based on machines in production at the time of publication. Magnum Power Products LLC reserves the right to change any portion of this information without notice.*

DO NOT MODIFY or use this equipment for any application other than which it was designed for.

Magnum Power Products LLC recommends that a trained and licensed professional perform all electrical wiring and testing functions. Any wiring should be in compliance with the United States National Electric Code (NEC), state and local codes and Occupational Safety and Health Association (OSHA) guidelines.

Keep a copy of this manual with the unit at all times. Additional copies are available from Magnum Power Products LLC, or can be found at **www.m-p-llc.com**. An engine operator's manual is supplied with the unit at the time of shipment from the factory. The manual provides detailed operation and maintenance procedures for the engine. Additional copies of the engine operator's manual are available from the engine manufacturer.

MAGNUM POWER PRODUCTS LLC

215 Power Drive • Berlin, WI 54923

U.S.A.

Phone: 920-361-4442

FAX: 920-361-4416

Toll Free: 1-800-926-9768

www.m-p-llc.com

For technical or parts **QUESTIONS**, please contact the Magnum Power Products LLC Customer Support or Technical Support team at 1-800-926-9768. Please have your serial number available.

To **ORDER SERVICE PARTS**, please contact the dealer from which you purchased the unit, or call Magnum Power Products LLC to locate a dealer in your area.

Engine Make: _____

Engine Serial Number: _____

Engine Model Number: _____

Generator Make: _____

Generator Model Number: _____

Generator Serial Number: _____

Unit Model Number: _____

Unit Serial Number: _____

▲ WARNING

CALIFORNIA PROPOSITION 65 WARNING: Diesel engine exhaust and some of its constituents are known to the state of California to cause cancer, birth defects and other reproductive harm.

TABLE OF CONTENTS

	Page
INTRODUCTION	2
SAFETY NOTES	4
OPERATING SAFETY	4
ENGINE SAFETY	5
SERVICE SAFETY	5
TOWING SAFETY	6
REPORTING TRAILER SAFETY DEFECTS	6
SAFETY SYMBOL SUMMARY	7
SPECIFICATIONS	8
UNIT SERIAL NUMBER LOCATIONS	9
EXTERIOR COMPONENT LOCATIONS	10
MAIN CONTROL PANEL COMPONENTS	11
MAGNUM DIGITAL CONTROLLER (MDC)	12
DIGITAL CONTROLLER FEATURES AND FUNCTIONS	12
GENERATOR MONITORING	13
ENGINE MONITORING	13
WET STACKING	15
FINE VOLTAGE ADJUSTMENT	15
PRE-START CHECK LIST	16
MANUAL STARTING OF THE GENERATOR	16
“AUTO” (REMOTE) STARTING OF THE GENERATOR	18
SHUTTING DOWN THE GENERATOR	18
MDC CONTROLLER INFORMATION DISPLAYS, FUNCTIONS, AND RESET	19
MAGNUM DIGITAL CONTROLLER (MDC) – GENERATOR OPERATIONAL STATUS	19
MAGNUM DIGITAL CONTROLLER (MDC) - ALARM MANAGEMENT	20
MAGNUM DIGITAL CONTROLLER (MDC) - LIST OF ALARMS	20
MAGNUM DIGITAL CONTROLLER (MDC) – HISTORY	21
ENGINE CONTROLLER	22
ADJUSTING THE DISPLAY BACKLIGHTING	22
RESETTING OF THE “TIME TO SERVICE” REMINDER	22
TROUBLESHOOTING AUTOMATIC SHUTDOWN CONDITIONS	22
GENERATOR OUTPUT CONNECTION LUGS	24
VOLTAGE SELECTOR SWITCH	24
RECEPTACLE PANEL OUTLETS	26
VOLTAGE REGULATION	26
EMERGENCY STOP SWITCH	26
MAIN CIRCUIT BREAKER	26
DERATING FOR ALTITUDE	27
REMOTE START TERMINAL BLOCK	27
TRANSFER SWITCH	27
LIFTING THE TRAILER	28
TOWING THE TRAILER	29
TRAILER WHEEL BEARINGS	29
JACK MAINTENANCE	30
LOWER RADIATOR HOSE HEATER OPTION - USE AND MAINTENANCE	30
GENERAL MAINTENANCE	31
BASIC MAINTENANCE SCHEDULE (ISUZU ENGINE)	32
AC WIRING DIAGRAM	33
AC WIRING RECEPTACLE PANEL OPTIONS	34
DC WIRING DIAGRAM	36
TRAILER LIGHTS WIRING DIAGRAM	37
SERVICE LOG	38

SAFETY NOTES



This is the safety alert symbol. It is used to alert you to potential personal injury hazards. Obey all safety messages that follow this symbol to avoid possible injury or death. This manual contains **DANGERS, WARNINGS, CAUTIONS, NOTICES** and **NOTES** which must be followed to prevent the possibility of improper service, damage to the equipment, personal injury or death. The following formatting options will apply when calling the reader's attention to the **DANGERS, WARNINGS, CAUTIONS, NOTICES** and **NOTES**.

▲ DANGER

INDICATES A HAZARDOUS SITUATION WHICH, IF NOT AVOIDED, WILL RESULT IN DEATH OR SERIOUS INJURY.

▲ WARNING

Indicates a hazardous situation which, if not avoided, could result in death or serious injury.

▲ CAUTION

Indicates a hazardous situation which, if not avoided, may result in minor or moderate injury.

NOTICE

Indicates a hazardous situation which, if not avoided, may result in property or equipment damage.

***Note:** Notes contain additional information important to a procedure and will be found within the regular text body of this manual.*

OPERATING SAFETY



Before using the generator, be sure you read and understand all of the instructions! This equipment was designed for specific applications; **DO NOT** modify or use this equipment for any application other than which it was designed for. Equipment operated improperly or by untrained personnel can be dangerous! Read the operating instructions and familiarize yourself with the location and proper use of all instruments and controls. Inexperienced operators should receive instruction from someone familiar with the equipment before being allowed to operate or set up the generator. The following points should be practiced at all times:

- The area immediately surrounding the generator should be dry, clean, and free of debris.
- Position and operate the generator on a firm, level surface.
- **NEVER** start a unit in need of repair.
- **DO NOT** operate the unit on a combustible surface.
- Make certain the generator is securely fastened to a good earthen ground before use.
- **NEVER** operate a generator if any of the following conditions exist:
 1. Noticeable change in engine speed.
 2. Loss of electrical output.
 3. Equipment connected to the generator overheats.
 4. Sparking occurs.
 5. Engine misfires or there is excessive engine/generator vibration.
 6. Protective covers are loose or missing.
 7. If the ambient air temperature is above 120°F (49°C).
- **NEVER** operate a unit while tired, distracted, or under the influence of drugs or alcohol.
- Make sure all lifting devices are attached securely and have enough weight-bearing capacity to hold the equipment safely. Always remain aware of the position of other people around you when lifting the equipment.

ENGINE SAFETY



Internal combustion engines present special hazards during operation and fueling! Failure to follow the safety guidelines described below could result in severe injury or death. Also read and follow all safety warnings described in the engine operator's manual. A copy of this manual was supplied with the unit when it was shipped from the factory.

- **DO NOT** run engine indoors or in an area with poor ventilation unless exhaust hoses are used. Diesel engine exhaust contains carbon monoxide, a deadly, odorless and colorless gas which, if inhaled, can cause nausea, fainting or death. Make sure engine exhaust cannot seep into closed rooms or ventilation equipment.
- **DO NOT** fill fuel tank near an open flame, while smoking, or while engine is running. **DO NOT** fill tank in an enclosed area with poor ventilation.
- **DO NOT** operate with the fuel tank cap loose or missing.
- **DO NOT** touch or lean against hot exhaust pipes or engine cylinders.
- **DO NOT** clean air filter with gasoline or other types of low flash point solvents.
- **DO NOT** remove engine coolant cap while engine is hot.
- **DO NOT** operate the unit without a functional exhaust system. Prolonged exposure to sound levels in excess of 85 dB(A) can cause permanent hearing loss. Wear hearing protection when working around a running engine.
- Keep all body parts and loose clothing away from moving parts on the engine and generator.
- Keep area around exhaust pipes and air ducts free of debris to reduce the chance of an accidental fire.
- Batteries contain sulfuric acid which can cause severe injury or death. Sulfuric acid can cause eye damage, burn flesh or eat holes in clothing. Protective eye wear and clothing are necessary when working on or around the battery. Always disconnect the **NEGATIVE** (-) battery cable from the corresponding terminal before performing any service on the engine or other components.

SERVICE SAFETY



This unit uses high voltage circuits capable of causing serious injury or death. Only a qualified electrician should troubleshoot or repair electrical problems occurring in this equipment.

- Before servicing the generator, make sure the engine start switch is turned to OFF, circuit breakers are open (off) and the negative terminal on the battery is disconnected. Open the main circuit breaker before disconnecting battery cables. **NEVER** perform even routine service (oil/filter changes, cleaning, etc.) unless all electrical components are shut down.
- **NEVER** allow water to accumulate around the base of the generator. If water is present, **DO NOT** service!
- **NEVER** service electrical components if clothing or skin is wet. If the unit is stored outside, check the engine and generator for any moisture and dry the unit before use.
- **NEVER** wash the unit with a power washer or high pressure hose.
- **NEVER** start the unit under load. The circuit breakers must be in the "OFF" position when starting the unit.
- **ALWAYS** disconnect the **NEGATIVE** (-) battery cable from the corresponding terminal before performing any service on the engine, generator or any other components. Remove the **NEGATIVE** (-) battery cable from the corresponding terminal if the unit is to be stored or transported.
- Replace all guards and safety devices immediately after servicing.
- **ALWAYS** connect the unit to a good earthen ground before use. Follow any local, state or United States National Electric Code (NEC) guidelines.

TOWING SAFETY



Towing a trailer requires care! Both the trailer and vehicle must be in good condition and securely fastened to each other to reduce the possibility of an accident. Also, some states require that large trailers be registered and licensed. Contact your local Department of Transportation office to check on license requirements for your particular unit.

- Check that the hitch and coupling on the towing vehicle are rated equal to, or greater than, the trailer's Gross Vehicle Weight Rating (GVWR).
- Check tires on trailer for tread wear, inflation, and condition.
- **NEVER** tow the trailer using defective parts! Inspect the hitch and coupling for wear or damage.
- Make sure the trailer hitch and the coupling are compatible. Make sure the coupling is securely fastened to the vehicle.
- Connect safety chains in a crossing pattern under the tongue and **ATTACH THE BREAKAWAY CABLE TO THE REAR BUMPER OF THE TOWING VEHICLE**. Do not attach the cable to the trailer hitch.
- Make sure directional and brake lights on the trailer are connected and working properly.
- Check that all lug nuts holding wheels on are tight and that none are missing.
- Maximum recommended speed for highway towing is 45 mph (72 km/h). Recommended off-road towing speed is not to exceed 10 mph (16 km/h). or less depending on terrain.

When towing, maintain extra space between vehicles and avoid soft shoulders, curbs and sudden lane changes. If you have not pulled a trailer before, practice turning, stopping, and backing up in an area away from heavy traffic.

A film of grease on the coupler will extend coupler life and eliminate squeaking. Wipe the coupler clean and apply fresh grease each time the trailer is towed.

REPORTING TRAILER SAFETY DEFECTS

If you believe your trailer has a defect which could cause a crash or could cause injury or death, you should immediately inform the National Highway Traffic Safety Administration (NHTSA) in addition to notifying Magnum Power Products LLC.

If NHTSA receives similar complaints, it may open an investigation; and if it finds that a safety defect exists in a group of vehicles, it may order a recall and remedy campaign. However, NHTSA cannot become involved in an individual problem between you, your dealer, or Magnum Power Products LLC.

To contact NHTSA, you may either call the Auto Safety Hotline toll-free at 1-888-327-4236 (TTY:1-800-424-9153), go to <http://www.safercar.gov>; or write to:

Administrator
NHTSA
1200 New Jersey Avenue S.E.
Washington, DC 20590

You can also obtain other information about motor vehicle safety from <http://www.safercar.gov>.

SAFETY SYMBOL SUMMARY

This equipment has been supplied with numerous safety and operating decals. These decals provide important operating instructions and warn of dangers and hazards. Replace any missing or hard to read decals and use care when washing or cleaning the unit. Decal placement and part numbers can be found in the parts manual. Below is a summary of the intended meanings for the symbols used on the decals.

	Safety alert symbol; used to alert you to potential personal injury hazards.		Asphyxiation hazard; operate in well ventilated area.
	Hot surface(s) nearby.		Dangerous voltage may be present.
	Belt/entanglement hazard; keep body parts clear of this area.		Anchor/tie down point.
	Fan hazard; keep body parts clear of this area.		Isolate generator to prevent electrocution hazard.
	Never change switch position while engine is running.		Use clean diesel fuel only.
	Stop engine before making connections.		Remove negative battery cable before performing any service on unit.
	Stop engine before fueling.		Read and understand the supplied operator's manual before operating unit.
	Hearing protection required while operating unit with doors open.		Unit electrical ground.
	Lift here only.		Fire/explosion hazard; keep open flames away from unit.
	Engine running.		Burn/scald hazard; pressurized steam.

00483

SPECIFICATIONS

Read this manual carefully before attempting to use the generator. The potential for property damage, personal injury or death exists if this equipment is misused or installed incorrectly. Read all of the manuals included with this unit. Each manual details specific information regarding items such as set up, use and service requirements.

SPECIFICATIONS ARE SUBJECT TO CHANGE WITHOUT NOTICE.

MAGNUM MODEL	MLG25	MLG25CAN
Engine		
Make/Brand.....	Isuzu	Isuzu
Model	4LE1NYGV-01	4LE1NYGV-03G
Horsepower - prime hp (kW)	32.1 (23.9)	32.1 (23.9)
Horsepower - standby hp (kW)	35.3 (26.3)	35.3 (26.3)
Operating Speed rpm	1800	1800
Displacement in³ (L)	134 (2.2)	134 (2.2)
Cylinders - qty	4	4
Fuel Consumption - 100% prime gph (Lph)	1.80 (6.81)	1.80 (6.81)
Battery Type	Group 24	Group 24
Battery Voltage (Quantity per Unit)	12V (1)	12V (1)
Battery Rating	720 CCA	720 CCA
Generator		
Make/Brand.....	Marathon Elec 	Marathon Electric
Model	282CSL1505 (X)	282CSL1505 (X)
Type, Insulation	Brushless, H	Brushless, H
Generator Set (Engine/Generator)		
3Ø - Standby kW (kVA)	20 (25)	20 (25)
Amps - 3Ø Standby 480V (208V) A	30 (69)	30 (60)
3Ø - Prime kW (kVA)	18 (23)	12 (23)
Amps - 3Ø Prime 480V (208V) A	28 (64)	28 (64)
1Ø - Standby kW (kVA)	16.0 (16.0)	16.0 (16.0)
Amps - 1Ø Standby - 240V A	67	67
1Ø - Prime kW (kVA)	15.0 (15.0)	15.0 (15.0)
Amps - 1Ø Prime - 240V A	63	63
Frequency Hz	60	60
Power Factor.....	1 (1Ø), 0.8 (3Ø)	1 (1Ø), 0.8 (3Ø)
Sound dB(A) 23 ft @ prime	68	68
Dimensions (L x W x H) in (m)	105 x 68 x 56	150 x 68 x 56
	(2.67 x 1.73 x 1.42)	(2.67 x 1.73 x 1.42)
Weights		
Dry Weight lbs (kg)	1640 (744)	1640 (744)
Operating Weight lbs (kg)	2038 (924)	2038 (824)
Capacities		
Fuel Tank Volume gal (L)	56 (212)	56 (212)
Usable Fuel Volume gal (L)	56 (212)	56 (212)
Coolant (incl. engine) qt (L)	11.6 (11.0)	11.6 (11.0)
Oil (incl. filter) qt (L)	6.7 (6.3)	6.7 (6.3)
Maximum Run Time hrs	31	31
AC Distribution		
Circuit Breaker Size	90	90
Voltage Selection	3 Position Switch (lockable).....	3 Position Switch (lockable)
Voltage Regulation.....	+/- 1%	+/- 1%
Voltages Available 1Ø.....	120, 139, 208, 220, 240, 277.....	120, 139, 208, 220, 240, 277
Voltages Available 3Ø.....	208, 220, 440, 480	208, 220, 440, 480
Trailer		
Number of Axles	1	1
Capacity - Axle Rating lbs (kg)	2200 (998)	2200 (998)
Tire Size in	15	15
Brakes.....	N/A	N/A
Hitch - Standard	2" Ball	2" Ball
Maximum Tire Pressure psi	50	50

UNIT SERIAL NUMBER LOCATIONS

Refer to the locations illustrated to find the unit ID tag and trailer ID tag on your unit. Important information, such as the unit serial number, model number, and Vehicle Identification Number (VIN) for your trailer are found on these tags. Record the information from these tags so it is available if the tags are lost or damaged. When ordering parts or requesting technical service assistance, you may be asked to provide this information.

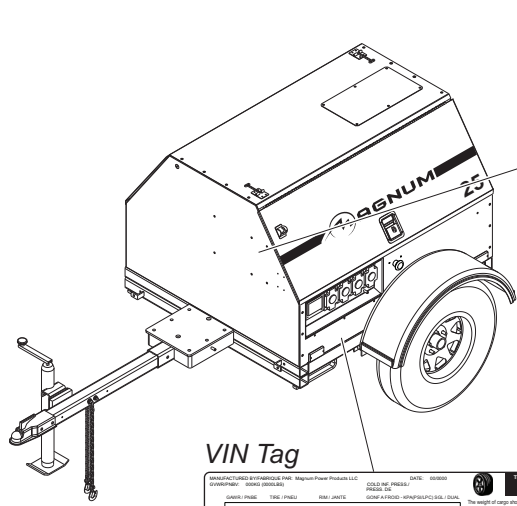

Unit ID Tag

Manufactured by
MAGNUM POWER PRODUCTS LLC
 A wholly owned subsidiary of
 Generac Power Systems, Inc.
 215 Power Drive • Berlin, WI 54823
 1.800.926.6788

Model Serial Number

Mfg. Code

Standard WT (lbs/kw)

1 ph. 1.0PF 3 ph. 0.8PF 3 ph. 1.0PF

KW

KVA

V

A

PHASE RATING

FOR ELECTRICIAN
 SUPPLY ALL
 NECESSARY WIRE

*Located on
inside of panel.*

VIN Tag

MANUFACTURED BY: MAGNUM POWER PRODUCTS LLC DATE: 02/05/2009
 COUNTRY OF ORIGIN: CHINA MAGNUM PARTS
 SERIAL NO. MAKE AND MODEL: HORN INDUSTRIES (USA) LLC

DATE

WEIGHT AND LOADING INFORMATION
 RECOMMENDED MAXIMUM GROSS WEIGHTS
 (weight to be determined by user, please reference 2009/2010 manuals)

SEE OWNER'S MANUAL FOR ADDITIONAL WEIGHTS AND LIMITS

MODEL: **XXX000** TYPE: **TRAILER**

U.S. SERIAL: **0000000000000000000**

EXTERIOR COMPONENT LOCATIONS

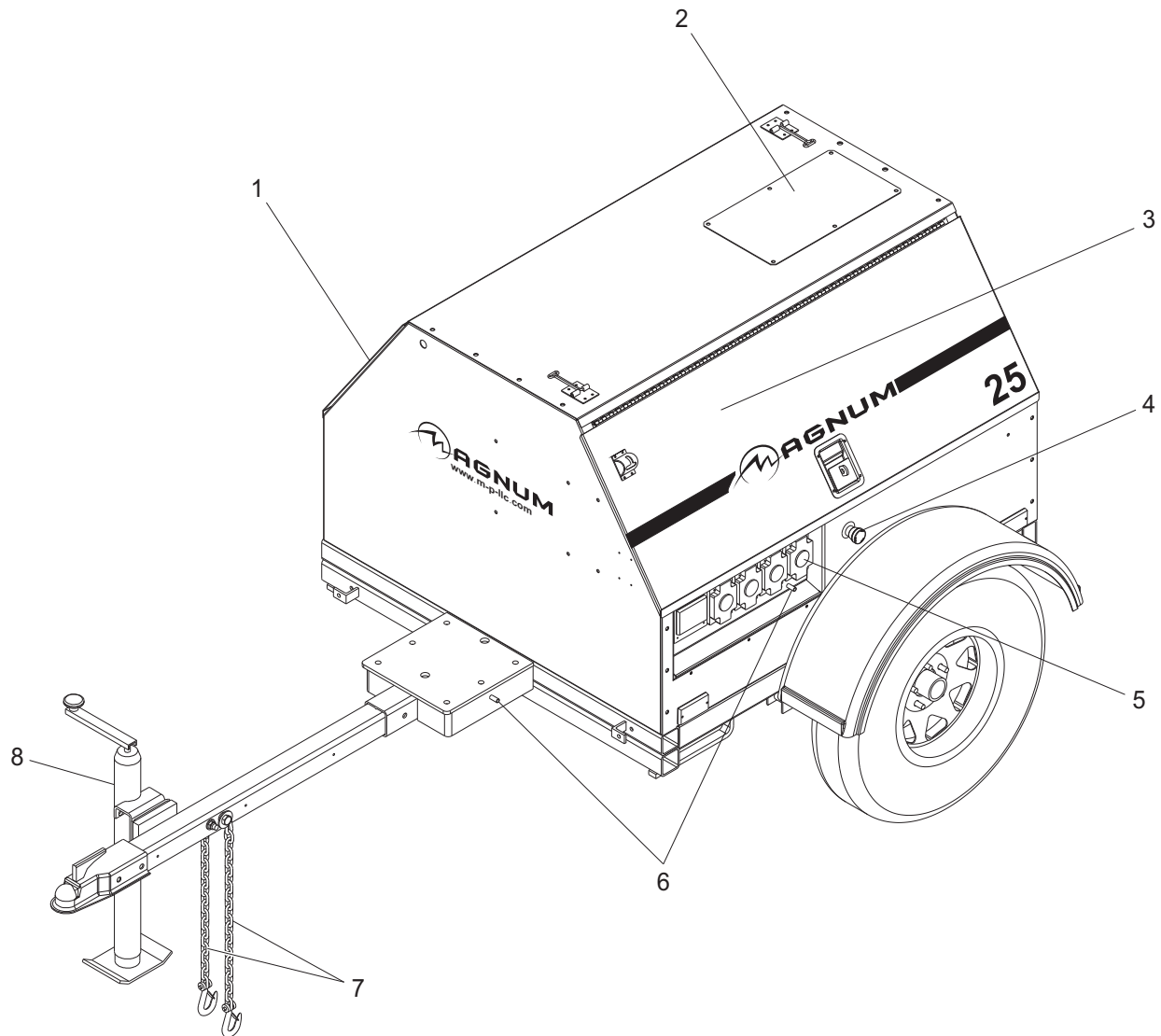

1. **FUEL FILLER LOCATION (under door):** Use clean **DIESEL FUEL ONLY**.
2. **RADIATOR ACCESS PANEL:** Remove this panel for engine coolant service.
3. **CONTROL PANEL LOCATION (under door):** See [“Main Control Panel Components” on page 11](#).
4. **EMERGENCY STOP SWITCH:** For emergency shutdown; stops engine and trips main circuit breaker.
5. **RECEPTACLE PANEL:** See [“Receptacle Panel Outlets” on page 26](#) for more information.
6. **GROUND STUDS (2):** For grounding generator and equipment connected to the equipment outlets.
7. **SAFETY CHAINS:** Used in a crossing pattern under the tongue to attach unit to towing vehicle.
8. **TONGUE JACK:** Used to level generator before starting.

MAIN CONTROL PANEL COMPONENTS

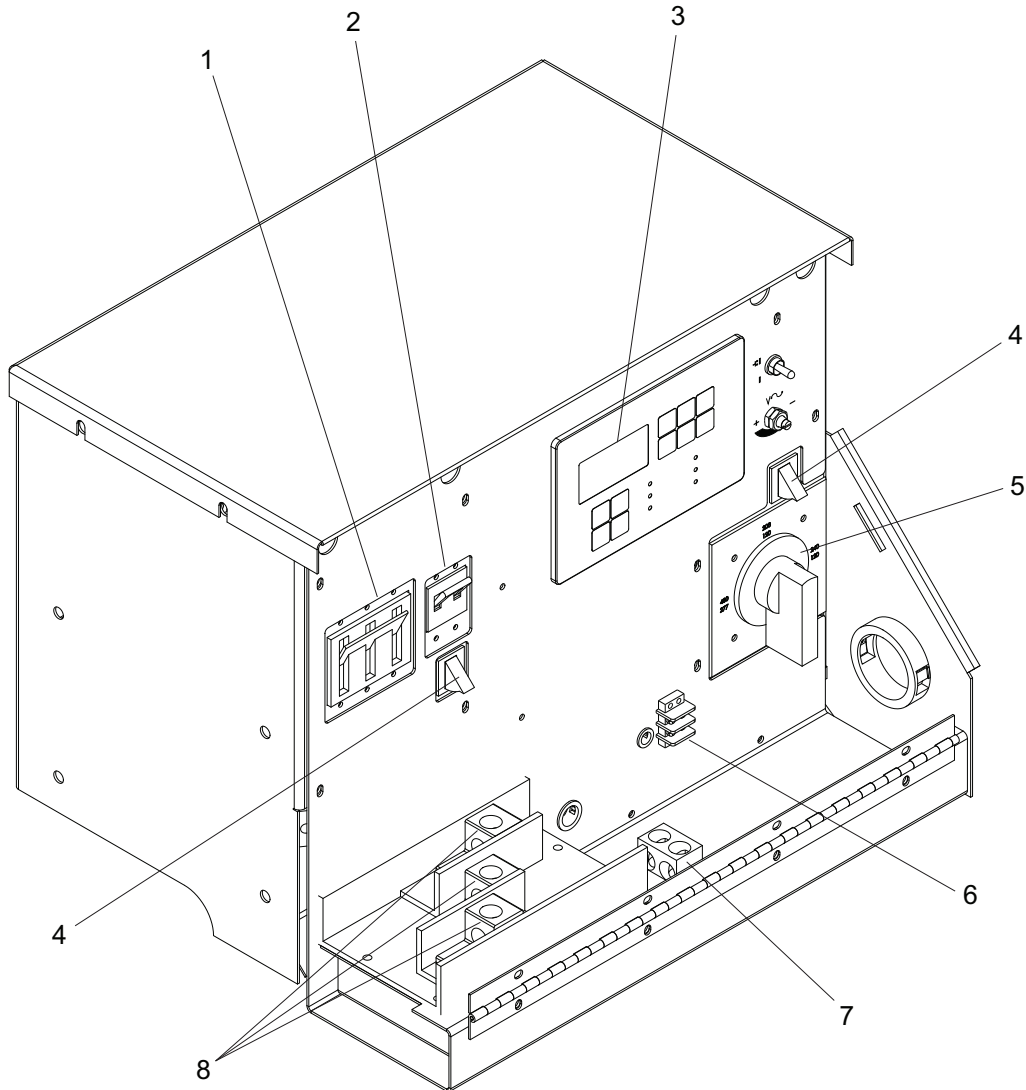

1. **MAIN CIRCUIT BREAKER (90A):** This breaker will disconnect power to the connection lugs.
2. **EQUIPMENT OUTLET MAIN CIRCUIT BREAKER (100A):** This breaker disconnects power to the equipment outlets.
3. **MAGNUM DIGITAL CONTROLLER (MDC):** See [page 12](#) for additional information.
4. **LUG DOOR SAFETY SWITCHES:** These switches will shut the generator down if the lug door is opened when the generator is running.
5. **VOLTAGE (PHASE) SELECTOR SWITCH:** This switch will change the generator output between three phase (3 \emptyset) and single phase (1 \emptyset) power. See "[Voltage Selector Switch](#)" on [page 24](#) for more information.
6. **REMOTE START TERMINAL BLOCK:** Allows for remote starting of the generator.
7. **GENERATOR GROUND CONNECTION LUG:** This lug is for connecting a good earthen ground per any local, state or National Electric Code (NEC) guidelines before starting the generator.
8. **GENERATOR OUTPUT CONNECTION LUGS:** These allow appropriate loads to be wired directly to the generator.

MAGNUM DIGITAL CONTROLLER (MDC)

The Magnum Digital Controller (MDC) is an enhanced digital generator controller used to start, stop and monitor the operation of the generator and the engine. The controller constantly monitors vital generator and engine functions for a number of pre-programmed alarm and fault conditions. When a fault condition occurs, the engine will shut down automatically and the Liquid Crystal Display (LCD) window will display the fault that caused the shutdown; to resume operation the fault condition must be resolved. The controller has the ability to provide the display readout in English and Spanish; other languages are available. A screen print out of the display screen is also available. This controller also records a “History” of the unit’s performance which may be viewed at any time and will not be removed or lost when the controller is powered down.

The MDC panel consists of five sections, including: the “CONTROL ON/OFF” toggle switch and fine voltage adjustment screw; the “OPERATION” keypad; the LCD window; the “DIAGNOSTICS” keypad; and the “STATUS” Light Emitting Diodes (LED’s).

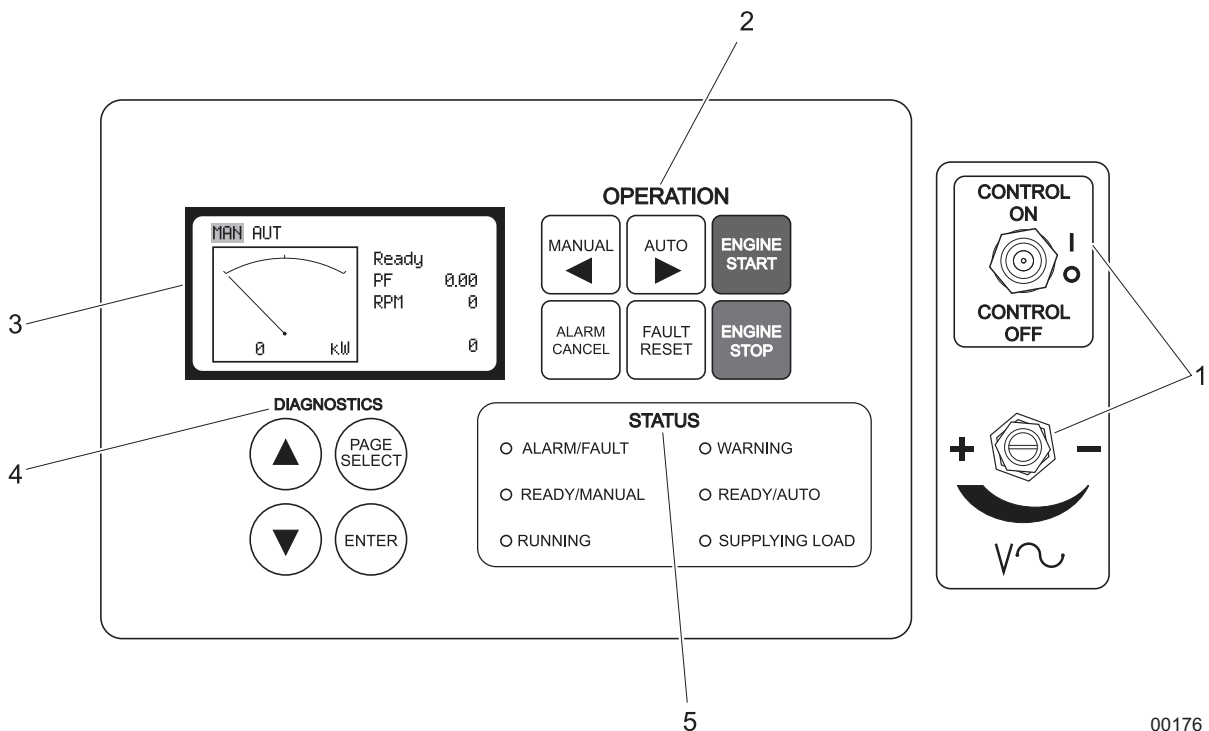

00176

DIGITAL CONTROLLER FEATURES AND FUNCTIONS

- The “CONTROL ON/OFF” Toggle Switch and Fine Voltage Adjustment Screw**
 - **“CONTROL ON/OFF” Toggle Switch:** This toggle switch powers-up the control panel and the controller.
 - **Fine Voltage Adjustment Screw:** This screw may be adjusted to set the generator output voltage after the voltage selector switch has been changed from one phase to another. This adjustment **MUST** be accomplished within 45 seconds of start-up so that the unit does not experience a shutdown alarm for over or under voltage. Refer to [“Fine Voltage Adjustment” on page 15](#) for more information.
- The “OPERATION” Keypad**
 - **“ENGINE START” Button:** The Power Screen Display must be in the “MAN” mode in the upper left corner of the LCD window display and the “Ready/Manual” LED lit in the “Status” portion of the controller. Press the green “ENGINE START” button to start the unit.
 - **“ENGINE STOP” Button:** Press the red “ENGINE STOP” button to shut down the unit and start the “Stop Value” timer.
 - **“MANUAL ◀” Button:** Press this button to change from the Automatic (remote) starting mode to Manual starting mode.
 - **“AUTO ▶” Button:** Press this button to change from Manual starting mode to Automatic (remote) starting mode.

- **“ALARM CANCEL” Button:** When an alarm is activated, either visually or audibly, press this button to silence and cancel the alarm.
- **“FAULT RESET” Button:** Press this button to clear the fault from the LCD window after the fault has been corrected. Press “FAULT RESET” and “ENTER” to clear the John Deere ECU Alarm List Codes.

3. The Liquid Crystal Display (LCD)

- This window will toggle between the generator display screen and the engine display screen upon start-up of the unit. By viewing these screens, the operator will be able to monitor both the engine and generator status while the unit is running.

4. The “DIAGNOSTICS” Keypad

- **“▲” Scroll-Up Button:** Press this button to scroll-up within the LCD window.
- **“▼” Scroll-Down Button:** Press this button to scroll-down within the LCD window.
- **“PAGE SELECT” Button:** Pressing this button will select the next display screen.
- **“ENTER” Button:** Pressing this button will place you inside the particular display to review the generators pre-programmed setpoints or parameters.

5. The “STATUS” Light Emitting Diodes (LED’s)

- These six LED’s will illuminate to display the current operational status of the generator:
 - Alarm/Fault: Indicates active or inactive alarms, but not reset shutdown alarms.
 - Warning: Indicates an active or inactive alarm, or a warning alarm that has not been reset.
 - Ready/Manual: Indicates the controller is ready to start and in the “MANUAL” mode.
 - Ready/Auto: Indicates the unit is in the “AUTO” mode ready for the remote start signal.
 - Running: Indicates the unit is running.
 - Supplying Load: Indicates a load is being applied to the generator.

GENERATOR MONITORING

Generator information is shown on the Liquid Crystal Display (LCD) window in a toggling manner with the engine information after the first 60 seconds of operation, then every five seconds. The generator display screen will show frequency, line to neutral voltage, line to line voltage and amperage.

***Note:** When loading the generator, it is important to observe the amperage to determine the load balance on each line of the generator. Minor load unbalances, usually 10% or less, will not cause any particular problems. Every effort should be made to distribute the load equally between all lines.*

- **Hertz:** Displays output frequency.
- **Generator Output Voltage:** Line to neutral display, single phase (1Ø).
- **Generator Output Voltage:** Line to line display, 3 phase (3Ø).
- **Amps:** Displays the AC output amperage produced by the generator.

GENERATOR DISPLAY SCREEN

Gen freq			60.0Hz
L1N	120V	L12	208V
L2N	120V	L23	208V
L3N	120V	L31	208V
A	226	222	223

ENGINE MONITORING

Engine information is shown on the Liquid Crystal Display (LCD) window in a toggling manner with the generator information after the first 60 seconds of operation and then every five seconds. The engine display screen will show oil pressure, engine coolant temperature, fuel level and battery voltage.

- **Oil Press:** Displays engine oil pressure. The display registers oil pressure between 0-100 psi (10-689 kPa). Normal operating pressure is between 35-80 psi (241-552 kPa).

- **Eng Temp:** Displays the temperature of the engine's coolant. If the coolant temperature exceeds the maximum water temperature of 230°F (110°C), the engine will automatically shut down. Zero will be displayed until a minimum temperature of 100°F (38°C) is reached.
- **Fuel Level:** Displays the level of fuel in the tank by percentage (50% = 1/2 tank, 75% = 3/4 tank, etc.). If the fuel level drops below a programmed low fuel point, usually at 15%, a low fuel warning and optional audio alarm will be activated. If the fuel level drops below the programmed low fuel limit, usually at 5 %, the engine will automatically shut down.
- **Vbat:** Displays the engine battery voltage. A normal reading is 13-14V on 12 volt systems and 24-26V on 24 volt systems (with the engine running).

ENGINE DISPLAY SCREEN

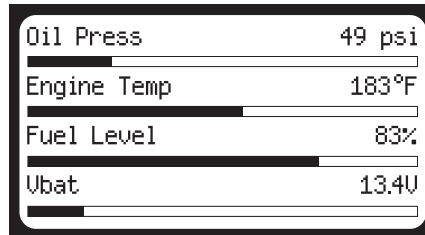

Additional information may be viewed while the unit is in "MANUAL" or "AUTO" mode. By pressing the "Page Select" button, the operator will select one of the following screens; "Running" screen, "Password" screen, or "History" screen. In each of these page selections the operator may press the "▲" or "▼" buttons on the "DIAGNOSTICS" keypad to display additional information as follows:

- **"Running" screen:** The operator may press the "▲" or "▼" buttons on the "DIAGNOSTICS" keypad to display the "Alarm List" screen, "ECU Alarm List" screen, "Run Hours" screen, "ECU Values" screen, engine display screen and generator display screen.

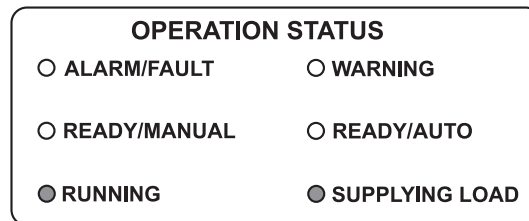
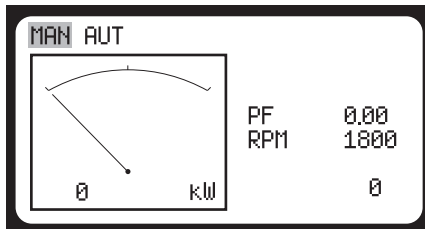

- **"Password" screen:** The operator may press the "▲" or "▼" buttons on the "DIAGNOSTICS" keypad to move the cursor (>) up or down a list of text.

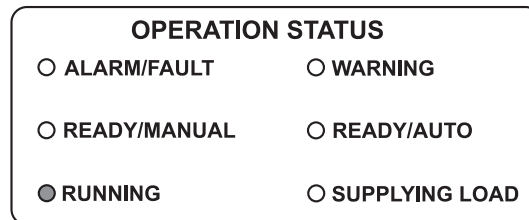
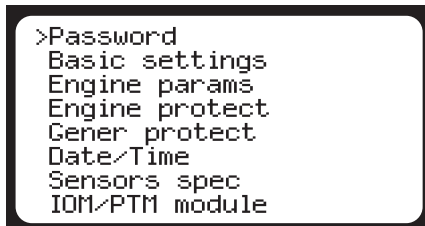

- **"History" screen:** The operator may press the "▲" or "▼" buttons on the "DIAGNOSTICS" keypad to move the cursor (>) up or down a list of recent alarm or shutdown codes. Pressing the "Enter" button at a particular selection will allow the operator to scroll to the right in the LCD window to view the generator operating parameters at the time of the alarm or shutdown. The history of alarms or codes is saved in the digital controller. The most recent alarm or code is the first to be listed, with the time/date of the alarm or code at the bottom of the screen. The controller stores up to 117 codes. When full, the controller will automatically

remove the oldest file. These codes will not be lost when the “CONTROL ON/OFF” toggle switch is powered off.

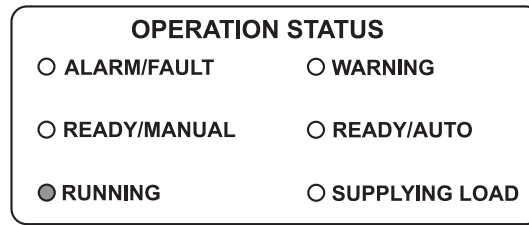
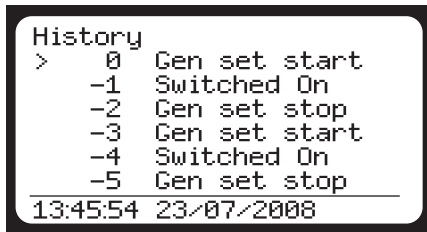

Note: To view the display screens longer, push the “Page Select” button on the “DIAGNOSTICS” keypad until you reach the “Ready” screen. Then press the “▲” or “▼” buttons to navigate to the screen you want. The screen will display for approximately 45 seconds.

WET STACKING

The generator is powered by a diesel engine. Diesel engines are susceptible to wet stacking if lightly loaded. Wet stacking occurs when an engine is run at less than 30% of its full load capacity, causing unburned fuel to accumulate in the exhaust system. Wet stacking can be detected by continuous black exhaust when the unit is under a constant load. It can also cause fouling of injectors and buildup on engine valves. Diesel engines operate properly when applied loads are between 30% and 100% capacity. Appropriate generator sizing is determined by the anticipated load. If the unit is in a wet stack condition, load the unit heavily for five hours or until the exhaust is clear.

FINE VOLTAGE ADJUSTMENT

Upon start-up of the generator, the “Running” screen of the Magnum Digital Controller (MDC) will display “V Detect” and will countdown from 45 seconds to zero. This is a safety feature of the controller to protect the generator from over or under voltage upon start-up.

“V Detect” is a 45 second time delay and count down process before the MDC records the generator nominal output voltage. This nominal generator voltage is then compared to the current set point voltage of the voltage selector switch. If the nominal voltage recorded by the controller is greater than or lower than the current set point voltage of the voltage selector switch setting by 10% or more, the controller will shut the generator down automatically. The display will read: Wrn VG1 or 2 or 3 Under/Over and/or Sd Vg1 or 2 or 3 Under/Over. This means the controller warned (“WRN”) or even shut down (“SD”) the unit due to an output voltage irregularity.

The output voltage of the generator may be adjusted after the generator is running by using the fine voltage adjustment screw. The adjusting screw is located directly below the control On/Off toggle switch on the control panel. This screw turns a rheostat that will provide an increase (“+”) or a decrease (“-”) in the generator output voltage as displayed on the generator screen on the MDC. When making this adjustment, if the voltage is increased or decreased too fast or too slow, the unit will automatically shut down. This adjustment needs to be made within the 45 second delay and countdown to zero period.

To adjust the output voltage, check the output voltage on the Liquid Crystal Display (LCD) window labeled Gen freq & Hz. Look at the “L1N” voltage or the “L12” voltage on the display. The generator nominal output voltage should be within 10% of the voltage rating on the voltage selector switch.

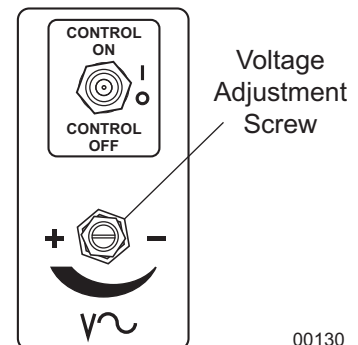

To adjust the output voltage, use a flat head screwdriver to turn the screw in the desired direction until the required voltage shown on the LCD window matches the stated voltage on the voltage selector switch.

For Example: With the voltage selector switch set to “208/120V” 3 Phase position, the voltage displayed on the Gen freq & Hz screen must be within $\pm 10\%$ of the 208/120 position (188-228 V Line to Line/108-132 V Line to Neutral).

If the voltage is not set within 10% of the applied voltage or the voltage is not reset within the 45 second delay period, the generator will shut down automatically and the display will read Wn VG1 or 2 or 3 Under/Over and/or Sd Vg1 or 2 or 3 Under/Over.

Note: Each time the voltage selector switch is changed from one setting to another, an adjustment will need to be made to the fine voltage using fine voltage adjustment screw.

PRE-START CHECK LIST

Before starting the generator, carefully read the pre-start check list. Make sure that all of the items are checked before trying to start the generator. This check list applies to both manual and remote starting of the generator.

- Read and understand **ALL** safety sections at the beginning of this manual.
- Make sure the control “ON/OFF” toggle switch is in the OFF “O” position.
- Make sure the circuit breakers (main and convenience) are switched OFF “O”.
- Check that the generator is properly grounded to a good earthen ground per local and NEC regulations.
- Verify all electrical connections at the connection lugs are tight and wired correctly?
- Check the voltage selector switch and make sure it is set to the desired voltage.
- Before drawing a load, use the potentiometer to verify the voltage is fine tuned to the correct voltage for the application.
- Is the generator sitting level?
- Thoroughly check for any water inside, on, or near the generator. Dry the unit before starting.
- Check oil, coolant, and fuel levels and engine battery connections.
- Check the engine fan belt tension and condition.
- Check the engine fan belt guard.
- Check the engine exhaust system for loose or rusted components.
- Check the radiator and surrounding shroud for debris.
- Are any of the generator covers loose or missing?
- Are all preventive maintenance procedures up to date?
- Check that the battery disconnect switch is on, if equipped.

MANUAL STARTING OF THE GENERATOR

1. Move the control “ON/OFF” toggle switch to the “CONTROL ON/I” position.

⚠ DANGER

CARBON MONOXIDE: USING A GENERATOR INDOORS CAN KILL YOU IN MINUTES!

2. The Liquid Crystal Display (LCD) window will quickly display system information, all Light Emitting Diodes (LED's) will flash.

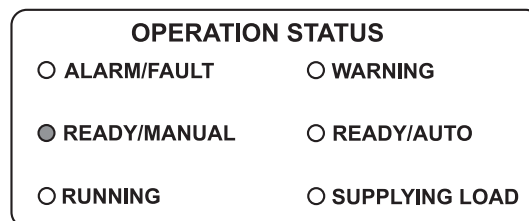
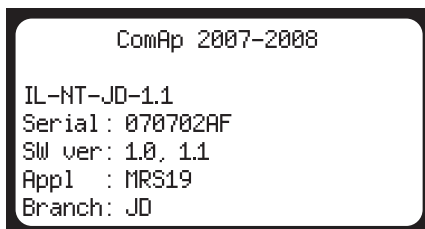

3. The LCD window will indicate “MAN” (manual) mode and “Ready”. The Ready/Manual LED will be lit.

Note: The unit must be in the “MAN” Mode with the Ready/Manual LED lit to start the unit.

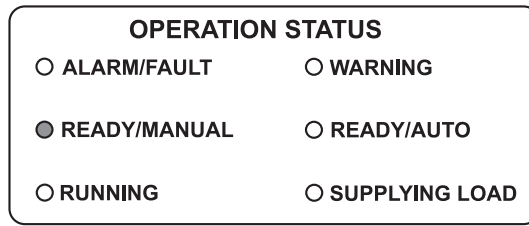
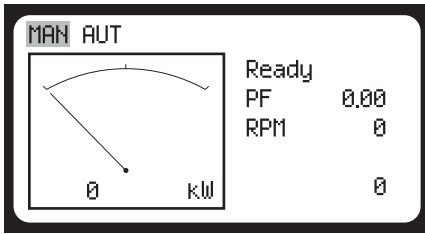

4. Press the green “ENGINE START” button. The prestart (preheat) screen will be displayed (if equipped) and a countdown will begin from 20 seconds to 0.

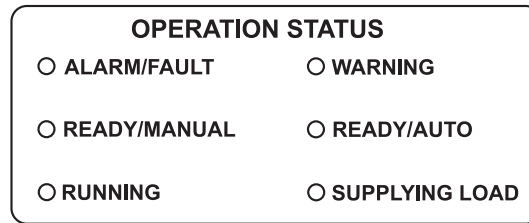
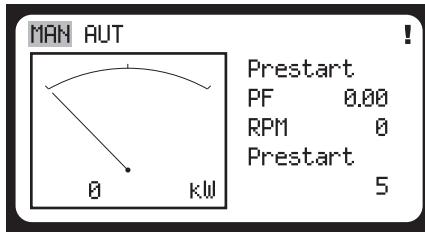

5. The starting screen will be displayed. The engine will crank and start running.

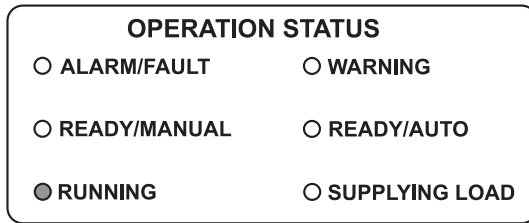
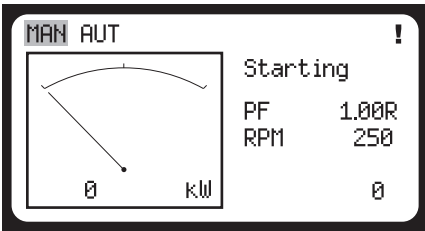

6. The running screen will display.

Note: It may take a few seconds for the engine to run smoothly and reach its governed operating speed. The 45 second “V Detect” time delay will start to count down.

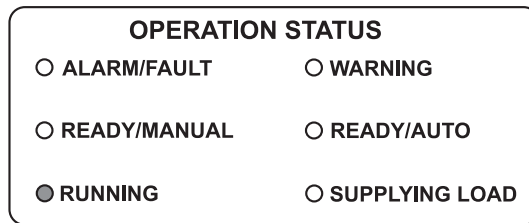
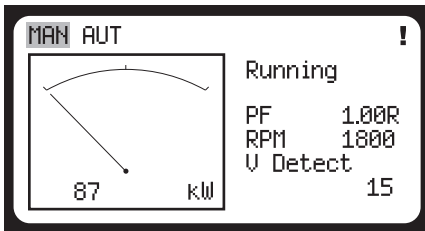

7. The LCD window will then toggle from the running screen to the generator display screen and then to the engine display screen.

GENERATOR DISPLAY SCREEN

Gen freq	60.0Hz		
L1N	120V	L12	208V
L2N	120V	L23	208V
L3N	120V	L31	208V
A	226	222	223

ENGINE DISPLAY SCREEN

Oil Press	49 psi
Engine Temp	183°F
Fuel Level	83%
Ubat	13.4V

8. If the engine does not start after the first cranking attempt, the engine will pause for 15 seconds to allow the starter to cool. The LCD window will show “PAUSE”. The engine will make two more attempts to start for a total of three crank cycles.

9. Should the engine not start and run within three starting cycles, the LCD window will show “SD Start fail”. The starting sequence may be repeated after the starter has had a minimum of two minutes to cool. Press the “FAULT RESET” button to clear the controller. To start the unit, press the green “ENGINE START” button.

Note: *The engine controller may skip the preheat engine steps on some of the larger models.*

10. Once the engine starts, it will immediately begin speeding up to a constant 1800 rpm. The engine may hunt or change speeds until operating speed is reached. After a few minutes of operation, the engine will be warmed up and the LCD window will show engine and generator operating parameters. Temperature will be shown as “0” until the engine temperature is approximately 100°F (38°C).
11. Check the generator for excessive noise or vibration and any coolant, oil, or fuel leaks before applying any loads.
12. Check that the AC output voltage is correct. The output voltage can be fine adjusted by using the fine voltage adjustment screw (rheostat), as described on [page 26](#).
13. Check that the frequency (Hz) is correct. With no loads connected to the generator, the frequency should read approximately 60 Hz, depending on the type of engine governing used.
14. If all wiring connections have been attached and secured correctly, switch the main circuit breaker to the “ON/I” position and then add any loads attached to the convenience outlets by switching the respective circuit breaker to the “ON/I” position. You will notice a slight change in engine sound when a load is applied to the unit.

“AUTO” (REMOTE) STARTING OF THE GENERATOR

The “AUTO” button is used when the generator is started from a location other than the control panel and by using a dry-contact closure remote start switch (transfer switch). “AUTO” (remote start) is the normal setting when the generator is being used as a standby power supply. Before putting the generator in the “AUTO” mode, review sections [“Pre-Start Check List” on page 16](#) and [“Remote Start Terminal Block” on page 27](#). Also follow all safety warnings and information on isolating the generator with a transfer switch if the unit is to be used as a standby power supply, described on [page 27](#). Then continue with the steps described below:

1. Perform a manual start of the generator at least once to verify the engine is operating correctly.
2. If a check of the remote start circuit is desired, remove the wires from the remote start terminal block and press the “AUTO” button. The Liquid Crystal Display (LCD) window should highlight “AUT” in the upper left corner. Attach a jumper wire (minimum 16 gauge) across the two terminals on the remote start terminal block. This applies a ground to the Magnum Digital Controller (MDC) to close the starting circuit contacts. The engine should crank, start, and run.
3. Remove the jumper wire from the remote start terminal block and the engine will stop. Reconnect any necessary wires from the remote start switch (transfer switch) to the remote start terminal block.
4. Confirm unit is in “AUTO” mode. The LCD window should have “AUT” highlighted in the upper left corner.
5. Close (set to “ON/I”) the main circuit breaker.
6. Secure the generator by closing and locking all access doors.
7. The generator is now ready for remote starting.

SHUTTING DOWN THE GENERATOR

Check with personnel using power supplied by the generator and let them know the power is going to be turned off. Make sure the power shut down will not create any hazards by accidentally turning off equipment that needs to be kept on (pumps, compressors, lights, etc.).

1. Remove all loads from the generator by opening all circuit breakers (turn to OFF/“O”).
2. Let the engine run for approximately five minutes to allow it to cool down.
3. Push the red “ENGINE STOP” button. Pressing “ENGINE STOP” will result in the generator going into the shutdown cycle and starting a 15 second shutdown timer called “Stop Value.” If the unit does not shut down within 15 seconds, a “Stop Fail” alarm will be displayed on the Liquid Crystal Display (LCD) window.
4. Move the “CONTROL ON/OFF” toggle switch to the “CONTROL OFF/O” position.

⚠ CAUTION

Always switch all circuit breakers to the OFF/"O" position to prevent starting the generator under load.

Note: For extended storage time, disconnect the battery. Refer to the engine operator's manual for extended storage requirements.

MDC CONTROLLER INFORMATION DISPLAYS, FUNCTIONS, AND RESET

The Magnum Digital Controller (MDC) constantly monitors vital generator and engine functions for a number of operation, alarm, and fault conditions. When a fault condition occurs, the engine will shut down automatically and the Liquid Crystal Display (LCD) window will show the fault that has caused the shutdown. To resume operation, the fault condition must be resolved. To reset the controller and resume operation, press the "FAULT RESET" button.

The operation of the Magnum Digital Controller (MDC) is divided into the following sections:

MAGNUM DIGITAL CONTROLLER (MDC) – GENERATOR OPERATIONAL STATUS

The Magnum Digital Controller (MDC) displays the operational status of the generator using the following codes:

No.	Engine State	Description
1	AfterCool	Engine aftercooling, cooling pump output is closed.
2	Cooling	The unit is cooling before stop.
3	Cranking	Engine is cranking.
4	EmergMan	Emergency Manual gen-set operation.
5	Init	Autotest during controller power on.
6	Loaded	The unit is running at nominal speed and GCB OPEN/CLOSE is closed.
7	Not Ready	The unit is not ready to start.
8	Pause	Pause between start attempts.
9	Prestart	Prestart sequence in process, prestart output is closed.
10	Ready	The unit is ready to run.
11	Running	The unit is running at nominal speed.
12	Shutdown	Shutdown alarm is activated.
13	Starting	Starting speed is reached and the <i>idle timer</i> is running.
14	Stop	Stop.

No.	Electrical State	Description
1	StabilTO	Stabilization Timeout

MAGNUM DIGITAL CONTROLLER (MDC) - ALARM MANAGEMENT

The Magnum Digital Controller (MDC) is capable of displaying the following alarms:

No.	Type	Description
1	Sensor fail (FIs)	Sensor fail is detected when measured value is 6% out of the selected characteristic. Sensor fail is indicated by ##### symbol instead of measured value.
2	Warning (WRN)	When warning comes up, see list of possible alarms.
3	Shutdown (SD)	When the shutdown alarm comes up, the digital controller opens outputs GCB CLOSE/OPEN, FUEL, SOLENOID, STARTER and PRESTART to stop the engine immediately.

MAGNUM DIGITAL CONTROLLER (MDC) - LIST OF ALARMS

Shutdown and warning fault conditions and the displayed message are described in the following table:

No.	Events Specification	Protection Type	Information on Binary Output Available	Description
1	AnInIOM Sd	SD	YES	Shutdown alarm configurable on the input of IG-IOM/IGS-PTM.
2	AnInIOM Wrn	WRN	YES	Warning alarm configurable on the input of IG-IOM/IGS-PTM.
3	Battery Flat (low battery)	SD	YES	If the controller switches off during starting sequence due to bad battery condition, it doesn't try to start again and activates this protection.
4	Binary Input	CONFIG.	YES	Configurable Warning/Shutdown alarms on the inputs of IL-NT.
5	ChrgAlternFail	WRN	YES	Failure of the alternator to charge the battery.
6	EmergencyStop	SD	NO	If the red <i>Emergency Stop</i> button is pushed or opened, shutdown is immediately activated.
7	Engine Temp Sd	SD	NO	Water temperature is greater than <i>Sd Water Temp</i> setpoint.
8	Engine Temp Wrn	WRN	YES	Water temperature is greater than <i>Wrn Water Temp</i> setpoint.
9	Fgen<, >	SD	YES	The generator frequency is out of limits given by <i>Gen >f</i> and <i>Gen <f</i> setpoints.
10	Fuel Level Sd	SD	YES	Fuel level is smaller than <i>Sd Fuel Level</i> setpoint (5%).
11	Fuel Level Wrn	WRN	YES	Fuel level is smaller than <i>Wrn Fuel Level</i> setpoint (15%).
12	GCB fail	SD	NO	Failure of the generator circuit breaker.
13	Igen unbl	SD	NO	The generator current is unbalanced.
14	Low BackupBatt	WRN	NO	RTC backup battery is flat (low).
15	Oil Press Sd	SD	NO	Oil pressure is smaller than <i>Sd Oil Press</i> setpoint.
16	Oil Press Wrn	WRN	YES	Oil pressure is smaller than <i>Wrn Oil Press</i> setpoint.
17	Overload	SD	YES	The load is greater than the value given by <i>Overload</i> setpoint.
18	Overspeed	SD	YES	The protection comes active if the speed is greater than <i>Overspeed</i> setpoint.

No.	Events Specification	Protection Type	Information on Binary Output Available	Description
19	ParamFail	NONE	NO	Wrong checksum of parameters. Happens typically after downloading new firmware or changing of the parameter. The controller stays in INIT mode. Check all parameters, write at least one new parameter.
20	PickupFault	SD	NO	Failure of the magnetic pick up sensor for speed measurement.
21	Sd IOM fail	SD	NO	IOM/IGS-PTM module.
22	SprinklActive	WRN	NO	The protection is active if the output <i>Sprinkler</i> is closed.
23	Start failed	SD	YES	Unit did not start.
24	Stop fail	SD	YES	Unit did not stop.
25	Ubat	WRN	YES	Battery voltage is out of limits given by <i>Batt Undervolt</i> setpoints.
26	Underspeed	SD	YES	During starting of the engine, when the RPM reaches the value of <i>Starting RPM</i> setpoint, the starter is switched off and the speed of the engine can drop under <i>Start RPM</i> again. Then the <i>Underspeed</i> protection becomes active. Protection evaluation starts 5 seconds after start up.
27	Vgen<, >	SD	YES	The generator voltage is out of limits given by <i>Gen <V</i> and <i>Gen >V</i> setpoints.
28	Vgen unbal	SD	NO	The generator voltage is unbalanced more than the value of <i>Volt unbal</i> setpoint.
29	Wrn ECU Alarm	WRN	NO	ECU alarm list is not empty.
30	Wrn RA15 fail	WRN	NO	Warning alarm in case of lost connection to IGL=RA15 module.
31	WrnMaintenance	WRN	NO	The period for servicing is set by the <i>WrnMaintenance</i> setpoint. The protection comes active if the running hours of the engine reach this value.

MAGNUM DIGITAL CONTROLLER (MDC) – HISTORY

The Magnum Digital Controller (MDC) stores a record of each important event in the history file of the controller. The history file seats 117 records. When the history file is full, the oldest records are removed.

No.	Record Structure Abbreviation	Historical Value
1	AIM1	IG-IOM, IGS-PTM analog input 1 value (when configured IG-IOM, IGS-PTM)
2	Date	Date of historical event in format DD/MM/YY
3	OilP	IL-NT analog input 1 value (default: oil pressure)
4	FC	ECU alarm FailureCode
5	Vg2	Generator voltage L2
6	RPM	Engine speed
7	Ig2	Generator current L2
8	Ubat	Battery voltage
9	FMI	ECU alarm failure mode identifier
10	EngT	IL-NT analog input 2 value (default: water temperature)

ENGINE CONTROLLER

The Magnum Digital Controller (MDC) constantly monitors vital engine functions for a number of operation, alarm, and fault conditions. When an operation, alarm or fault condition occurs, the LCD display will alert the operator either visually or audibly. Press the “▲” Scroll-Up button (on the diagnostic keypad) to view the “Alarm List.” This will allow you to view a description of the fault, (See Figure 1).



Figure 1

ADJUSTING THE DISPLAY BACKLIGHTING

The backlighting on the Liquid Crystal Display (LCD) window may be adjusted brighter or darker by the operator whenever the Magnum Digital Controller (MDC) is powered up.

1. Press and hold “Enter” and press the “▲” or “▼” button on the diagnostics keypad to increase or decrease the display contrast as needed.
2. Release the “Enter” button when the desired backlighting is attained.

Note: Anytime an “*” is displayed on the LCD, the text or set point cannot be changed without the use of a password. Contact Magnum Power Products LLC Technical Support for assistance.

RESETTING OF THE “TIME TO SERVICE” REMINDER

The Magnum Digital Controller (MDC) will display the message “WrnMaintenance” when the unit is due for maintenance or service. The maintenance or service interval is set at 250 hours of engine running time. Once the unit has been serviced, the “Time to Service” reminder needs to be reset to the 250 hour interval. The following procedure demonstrates how to reset the running hours to 250:

1. With the unit shut down, power up the controller with the “Control On/Off” toggle switch. The initialization screen will be displayed. The controller will toggle automatically to the “Ready” display screen.
2. Press the “Page Select” button. The next screen will display lines of text; starting with the word “Password,” then “Basic Settings,” “Engine Params,” “Engine Protect,” etc. The top line has a (>) cursor before the word “Password”.
3. Press the “▼” button to move the (>) cursor down to the “Engine Protect” line of text.
4. Press Enter. “WrnMaintenance” will appear at the top left of the display screen. The current service time hour setting remaining (0) will be one line below it on the right side.
5. Press Enter. The current run time in hours will now appear on the left side of the display screen, directly under “WrnMaintenance.”
6. Press the “▲” button and reset the current run time hour setting to 250. If you pass the 250 time interval, use the “▼” button to get back to the 250 time interval.
7. Press “Enter” to save the current run time hour setting.
8. Move the “CONTROL ON/I” toggle switch to the “CONTROL OFF/O” position.

TROUBLESHOOTING AUTOMATIC SHUTDOWN CONDITIONS

LOW FUEL LEVEL SHUTDOWN

1. Check the fuel level on the Liquid Crystal Display (LCD) window. Confirm the generator is sitting level to ensure an accurate reading.

2. Check for leaks in the fuel tank. The fuel tank should not run dry under normal circumstances. The engine controller will shut the engine down when there is five percent of fuel remaining in the tank. This is done to keep the fuel lines from running dry.
3. If the fuel level is good and no leaks are found, check the fuel level sender and the connecting wiring for damage. To check for continuity between the sender and the engine controller, remove the bolts at the top and bottom of the control panel and open the panel like a door. Consult the appropriate DC wiring diagram in this manual for the proper path between the engine controller and the fuel level sender.

LOW OIL PRESSURE SHUTDOWN

1. Check the level of the engine oil with the dipstick. The engine controller will shut the engine down when the oil pressure is less than 20 psi (138 kPa). Add oil if required.
2. Visually inspect the engine for oil leaks.
3. If the oil level is good, restart the unit and verify the loss of oil pressure. Shut the engine down immediately if the oil pressure value does not read 5 psi (34 kPa) within five seconds.
4. Check the oil pressure sender on the engine block and the connecting wiring for damage. To check for continuity between the sender and the engine controller, remove the bolts at the top and bottom of the control panel and open the panel like a door. Consult the appropriate DC wiring diagram in this manual for the proper path between the engine controller and the pressure sender.
5. If the oil level, pressure sender, and wiring are good, the oil loss may be caused by engine failure. Consult the engine operator's manual for additional information on excessive oil consumption.

LOW COOLANT LEVEL SHUTDOWN

1. Allow the engine to cool. Confirm the unit is sitting level to ensure an accurate reading.
2. Check the coolant level in the radiator. Add coolant until it is 3/4" (2 cm) below the filler neck. Secure the radiator cap back into its original position.
3. Inspect coolant hoses, engine block and water pump for visible leaks.
4. Check engine oil to verify no coolant has mixed with it (oil will appear milky if coolant is present). Consult the engine operator's manual for additional information.

HIGH COOLANT TEMPERATURE SHUTDOWN

1. Check the coolant level in the overflow jug.
2. Restart the engine and read the coolant temperature to verify High Coolant Temperature Shutdown. Stop the engine immediately if the coolant temperature is 230°F (110°C) or more.
3. Allow the engine to cool. Add coolant to the overflow jug if it is low and then check the level of coolant in the radiator. Add coolant until it is 3/4" (2 cm) below the filler neck. Secure the radiator cap back into its original position.
4. Check the radiator shroud and ducting for blockage and remove any foreign matter.
5. Inspect coolant hoses, engine block and water pump for visible leaks.
6. Check the tension of the serpentine drive belt for the water pump.
7. Check the coolant temperature sender on the engine block and the connecting wiring for damage. To check for continuity between the sender and the engine controller, remove the bolts at the top and bottom of the control panel and open the panel like a door. Consult the appropriate DC wiring diagram in this manual for the proper path between the engine controller and the temperature sender.
8. If the sender and wiring are good and no other problems are found, remove the load on the generator and restart the engine. Observe the coolant temperature and shut the engine down immediately if it starts to overheat. Consult the engine operator's manual for additional information on engine overheating.

OVERCRANK SHUTDOWN

1. Check the fuel level in the tank.
2. Check for proper operation of the fuel pump.
3. Check the air filter for blockage.
4. If the engine will not start, consult the engine operator's manual for additional information on troubleshooting starting problems.

OVERSPEED OR UNDERSPEED SHUTDOWN

1. Disconnect all loads and restart the generator. Read the frequency (Hz) on the LCD display. With no loads on the generator, the frequency should read 60.0 Hz.
2. If the frequency is above or below 60.0 Hz, the engine speed will have to be adjusted. See the engine manual for throttle adjustments on mechanical governed units and see the electronic governor manual for electronically controlled units.

GENERATOR OUTPUT CONNECTION LUGS

The generator is equipped with connection lugs behind a door below the controller face. The lugs provide connection points for attachment of external loads to the generator. A large decal on the inside of the connection lug door details the proper connections for selected voltages.

⚠ WARNING

It is HIGHLY RECOMMENDED that only a trained and licensed electrician perform any wiring and related connections to the generator. Installation should be in compliance with the National Electric Code (NEC) as well as any local or state guidelines as required by law. Failure to follow proper installation requirements may result in equipment or property damage, personal injury or death.

⚠ WARNING

Before any connections are made to the generator, make sure that the main circuit breaker and the control power switch are in the OFF "O" position. Potentially lethal voltages may be present at the generator connection lugs.

⚠ DANGER

IMPROPER OR INCORRECT CONNECTIONS TO A BUILDING'S ELECTRICAL SYSTEM CAN CAUSE POTENTIALLY LETHAL VOLTAGE TO BACKFEED INTO UTILITY LINES. THIS MAY RESULT IN INJURY OR ELECTROCUTION TO UTILITY WORKERS NEARBY. MAKE SURE THE GENERATOR IS SUPPLYING POWER TO AN ISOLATED OBJECT OR BUILDING THAT IS NOT CONNECTED TO ANY UTILITY LINES.

Connections to the lugs should be made by running the power cables through the circular plastic bushing on the lower right side of the control box. **DO NOT** make any connections directly to the lugs without routing the cables through this bushing. The lug door is equipped with safety interlock switches that will automatically trip the main circuit breaker and disable the voltage regulator when the lug door is opened. Use a hex wrench to tighten the cable connections.

⚠ WARNING

Never attempt to disable or modify the lug door safety switches. Equipment damage, personal injury or death may result.

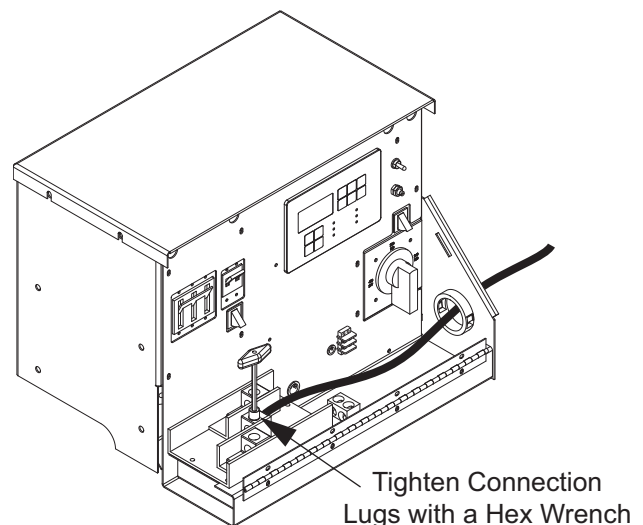

A ground connection is located next to the connection lugs.

The unit **MUST** be connected to a good earthen ground for proper operating safety. The ground connection should be in compliance with the National Electric Code (NEC) as well as any state or local guidelines or codes.

VOLTAGE SELECTOR SWITCH

The voltage selector switch is located under the lug door, directly below the control power switch. The selector switch is a three position switch that mechanically changes the connections between the generator output leads and the

connection lugs on the main control panel. Voltage ranges are selected by rotating the handle on the switch to the desired voltage.

Note: Three phase (3Ø) voltage is not available at **ANY** of the electrical receptacles. Three phase voltage is only available at the connection lugs.

NOTICE

NEVER CHANGE THE VOLTAGE SELECTOR SWITCH WHILE THE ENGINE IS RUNNING! This will cause severe arcing and damage to the switch and generator windings.

The voltage selector switch is equipped with a locking mechanism. Once the proper voltage has been selected, push the red latch on the inside of the switch handle up and insert a padlock through the handle. By locking the handle in place you will prevent unauthorized personnel from changing the switch settings.

Note: UNITS WITHOUT A CONVENIENCE OUTLET BUCK TRANSFORMER: When the voltage selector switch is in position for 480/277V 3Ø, voltage at the two GFCI duplex convenience outlets is 139V and the voltage at the twist-lock outlets is 240/139V (1Ø). When the voltage selector switch is in position for 208/120V 3Ø, voltage at the twist-lock outlets and at the GFCI outlets is 208/120V (1Ø).

NOTICE

Convenience outlets should not be used in the 480/277 voltage setting as the voltage will be higher and equipment damage could result.

480/277V
3-Phase

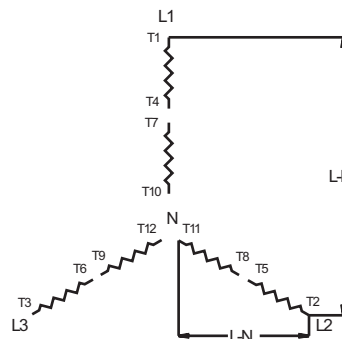
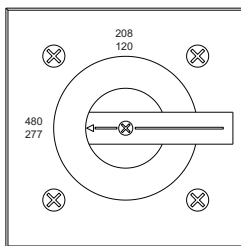

L1 - L2 = 480V L1 - N = 277V
L2 - L3 = 480V L2 - N = 277V
L3 - L1 = 480V L3 - N = 277V
N =

208/120V
3-Phase

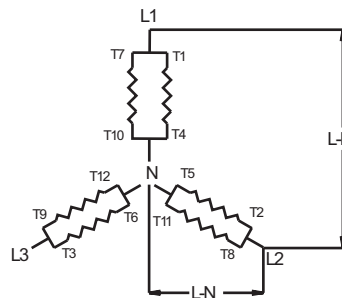
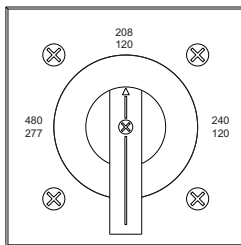

L1 - L2 = 208V L1 - N = 120V
L2 - L3 = 208V L2 - N = 120V
L3 - L1 = 208V L3 - N = 120V
N =

240/120V
1-Phase

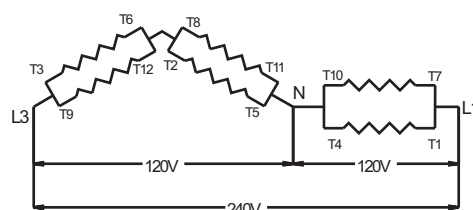
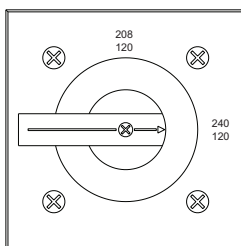

L1 - L3 = 240V L2 - N = -----
L1 - N = 120V L3 - N = 120V

RECEPTACLE PANEL OUTLETS

The unit is equipped with a receptacle panel for running accessories or tools from the generator. Power is supplied to the outlets any time the engine is running and the main circuit breaker and equipment outlets main circuit breaker are switched to the ON “I” position. Each outlet has its own individual circuit breaker, located inside the cabinet under a flip-up cover. Each circuit breaker corresponds with the outlet located directly below it.

Should the main breaker or equipment outlets main circuit breaker trip, remove some of the load to the outlets before turning them back on.

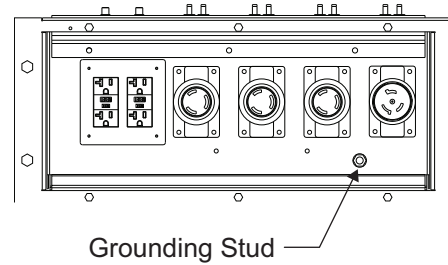

Note: To ensure proper grounding, anytime the generator is providing power to any equipment or load panels that do not have a grounded plug, a ground wire **MUST BE** added between the equipment and the grounding stud on the outlet panel per any local, state or NEC codes and guidelines.

VOLTAGE REGULATION

The electronic voltage regulator controls the output of the generator by regulating the current into the exciter field. The regulator has three screwdriver adjustable potentiometers that may be adjusted for voltage, stability and under frequency (U/F). The voltage regulator on the unit is adjusted before shipment from the factory. Contact Magnum Power Products LLC for additional information before attempting to adjust the voltage regulator.

EMERGENCY STOP SWITCH

The generator is equipped with one emergency stop switch, located on the side panel next to the receptacle panel. The red switch is clearly labeled “EMERGENCY STOP”. The switch can be accessed and activated with all doors closed and locked.

Activate the emergency stop switch by pushing the red button in until it locks down. This will trip the main circuit breaker which will open the contact, disconnecting the load to the connection lugs. This will also open the fuel circuit, shutting down the engine and the “Emergency Stop” fault will be displayed on the LCD. The switch will remain closed until it is pulled out.

Note: Use the “EMERGENCY STOP” only when the generator must be shut down immediately. For any other shut down, follow the detailed shut down procedure.

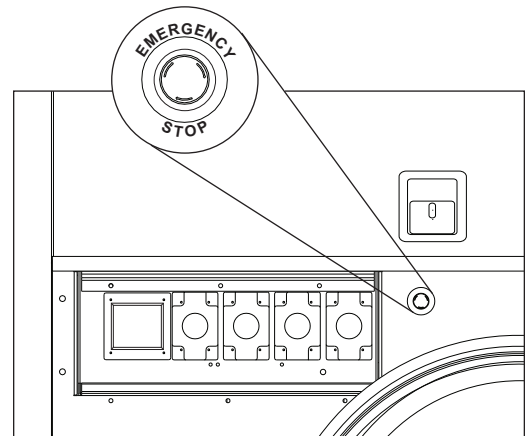

MAIN CIRCUIT BREAKER

The main circuit breaker is located on the main control panel. When the breaker is in the OFF “O” position, power is interrupted between the customer connection lugs and the generator. Once the connections have been made to the connection lugs and the generator has been started and allowed to reach normal operating temperature, the breaker may be switched to the ON “I” position.

The main circuit breaker will be tripped, disconnecting power to the connection lugs, if any of the following items occur while the unit is running:

1. Overload of the generator circuits to the connection lugs (208/120V only).
2. The lug box door covering the customer connection lugs is opened.
3. If the emergency stop switch is activated.

Make sure any problems that caused the main circuit breaker to trip are corrected before returning the switch to the ON “I” position.

NOTICE

The main circuit breaker interrupts power to the customer connection lugs only. The receptacle panel outlets have power even if the main circuit breaker is in the OFF "O" position. The equipment outlets main circuit breaker, located next to the main circuit breaker, will disconnect all power to the outlet panel.

DERATING FOR ALTITUDE

All generator sets are subject to derating for altitude and temperature; this will reduce the available power for operating tools and accessories connected to the receptacle panel outlets. Typical reductions in performance are 2-4% for every 1000 ft. (305 m) of elevation and 1% per 10°F (-12°C) increase in ambient air temperature over 72°F (22°C).

REMOTE START TERMINAL BLOCK

The remote start terminal block is located under the lug box door just below the voltage selector switch. It provides a connection for installation of a remote start switch which will allow the generator to be started by a remote dry-contact closure switch.

Before pressing the "AUTO" button, verify that the contacts on any remote switch linked to the generator are **OPEN**. If the contacts on a remote switch are closed, the generator will crank and start when "AUTO" is selected on the controller. Attach the switch leads to the two unused terminals on the generator's remote start block. For additional information on starting the generator, see ["Auto" \(Remote\) Starting Of The Generator" on page 18](#) of this manual.

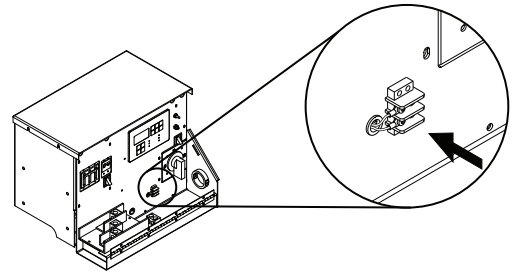

TRANSFER SWITCH

When the generator is used as a standby power supply, it must be equipped with a transfer switch which isolates it from the utility's distribution system. A transfer switch is designed to transfer electrical loads from the normal power source (utility) to the emergency power source (generator) when normal voltage falls below a prescribed level. The transfer switch automatically returns the load back to the normal source when power is restored back to operating levels.

⚠ DANGER

FAILURE TO ISOLATE THE GENERATOR FROM THE NORMAL POWER UTILITY CAN CAUSE POTENTIALLY LETHAL VOLTAGE TO BACKFEED INTO THE UTILITY LINES. THIS MAY RESULT IN INJURY OR ELECTRICUTION OF UTILITY WORKERS NEARBY. MAKE SURE THAT THE GENERATOR IS ISOLATED BY A TRANSFER SWITCH FROM ANY LOCAL UTILITY LINES. THIS ALSO APPLIES IF THE GENERATOR IS BEING USED AS A BACKUP TO SOME OTHER TYPE OF POWER SUPPLY.

Installation of a transfer switch or other type of remote starting device is the responsibility of the generator user. Installation of such devices must be performed by following all directions supplied by the manufacturer of the switch. If attaching generator to a power supply normally serviced by a utility company, notify the utility company and check local and state regulations. Familiarize yourself with all instructions and warning labels supplied with the switch.

⚠ WARNING

It is strongly recommended that ONLY a licensed electrician perform any wiring and any related connections to the generator. Installation should be in compliance with the National Electric Code as well as any state or local codes or regulations. Failure to follow these procedures could result in property damage, personal injury or death. Before any connections are attempted, make sure the main circuit breaker and the engine start switch are in the OFF "O" position and the negative (-) battery cable has been disconnected from the engine starting battery.

NOTICE

When using the generator as a stand by or substitute power supply, make sure the output voltage and phase rotation of the generator match those of the local power utility. Improper voltage or phase rotation may cause equipment damage or malfunction.

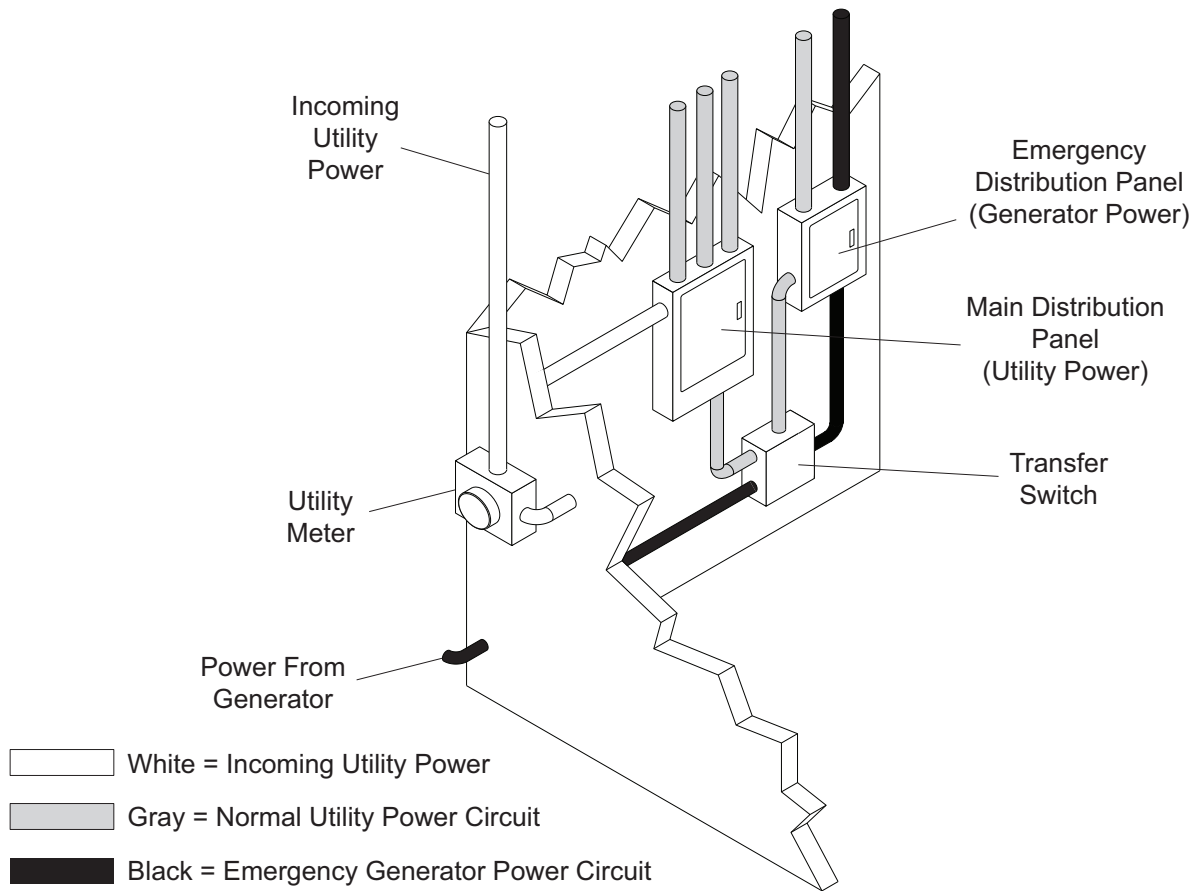

LIFTING THE TRAILER

1. Make sure the equipment being used to lift the generator has sufficient capacity.

Note: See [“Specifications” on page 8](#) for approximate weights.

2. Always remain aware of the position of other people and objects while moving the unit.
3. Use the forklift pockets (2) & (3) with care. Approach the unit as perpendicular as possible to avoid any damage to the unit. Make sure any obstructions are clear of the forklift tines before lifting.

Note: When lifting the unit using the optional lift structure, attach any slings, chains or hooks directly to the central lift point. The central lift point (1) is located between the two upper forklift pockets (2).

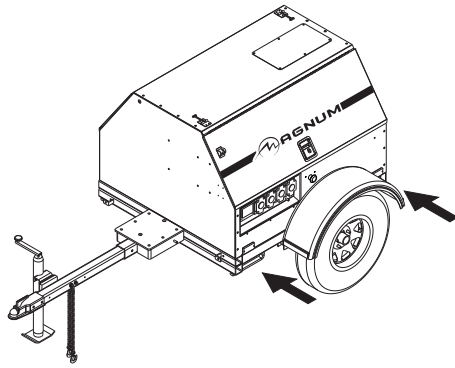

Trailer with Standard Forklift Pockets

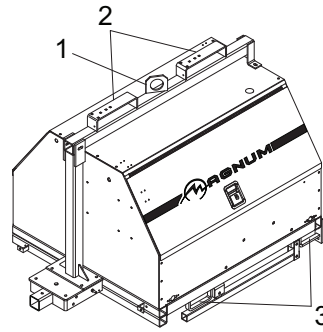

Unit with Optional Lift Structure

TOWING THE TRAILER

1. Use the jack to raise or lower the trailer onto the hitch of the towing vehicle. Lock the hitch coupling and attach the safety chains or cables to the vehicle. Release the jack locking pin and rotate the jack into the travel position. Make sure the locking pin snaps into place. To ensure proper operation of the jack, lube the grease fitting located on the leveling jack on the tongue.
2. Connect any trailer wiring to the tow vehicle. Check for proper operation of the stop and signal lights.
3. Make sure the doors are properly latched.
4. Check for proper inflation of the trailer tires. For maximum tire pressures, refer to the *"Specifications" on page 8*.
5. Check the wheel lugs. Tighten or replace any that are loose or missing. If a tire has been removed for axle service or replaced, tighten the lugs in the order shown to the following specifications:
 - A. Start all lug nuts by hand.
 - B. First pass tighten to 20-25 ft-lbs (27-33 Nm).
 - C. Second pass tighten to 50-60 ft-lbs (67-81 Nm).
 - D. Third pass tighten to 90-120 ft-lbs (122-162 Nm).

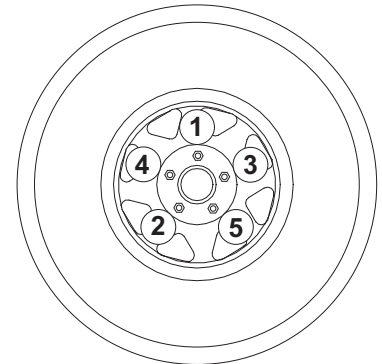

Note: After the first road use, retorque the lug nuts in sequence.

6. Maximum recommended speed for highway towing is 45 mph (72 km/h). Recommended off-road towing speed is not to exceed 10 mph (16 km/h) or less, depending on terrain.

TRAILER WHEEL BEARINGS

Some trailers are equipped with a grease zerk fitting to allow lubrication of the wheel bearings without the need to disassemble the axle hub. To lubricate the axle bearings, remove the small rubber plug on the grease cap, attach a standard grease gun fitting to the grease zerk fitting and pump grease into the fitting until new grease is visible around the nozzle of the grease gun. Use only a high quality grease made specifically for lubrication of wheel bearings. Wipe any excess grease from the hub with a clean cloth and replace the rubber plug when finished. The minimum recommended lubrication is every 12 months or 12,000 miles (19,312 km). More frequent lubrication may be required under extremely dusty or damp operating conditions.

JACK MAINTENANCE

The following procedures should be performed at least annually:

SIDE-WIND MODELS

- The internal gearing and bushings of the jack must be kept lubricated. Apply a small amount of automotive grease to the internal gearing by removing the jack cover, or if equipped, use a needle nose applicator or standard grease gun on the lubrication point found on the side of the jack near the crank. Rotate the jack handle to distribute the grease evenly.
- A lightweight oil must be applied to the handle unit at both sides of the tube for side-wind models.
- If equipped, the axle bolt and nut assembly of the caster wheel must also be lubricated with the same light weight oil.

TOP-WIND MODELS

- Apply a lightweight oil to the screw stem.

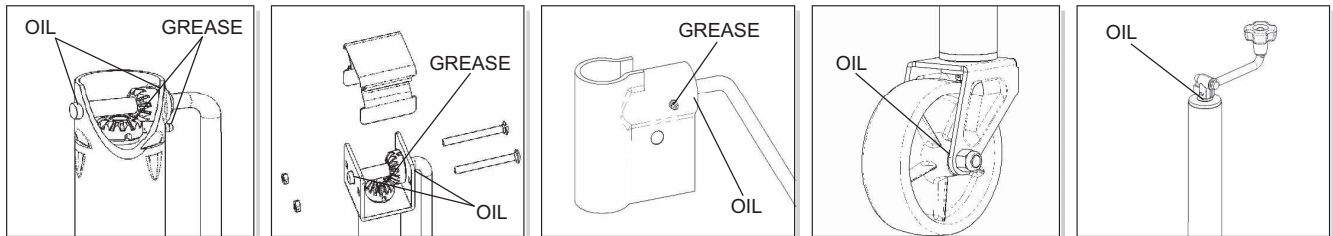

LOWER RADIATOR HOSE HEATER OPTION - USE AND MAINTENANCE

⚠ CAUTION

Improper use of the lower radiator hose heater could result in damage to the engine or personal injury. Do not modify the location of the lower radiator hose heater.

The following points should be followed when operating a unit equipped with a lower radiator hose heater:

- Ensure cooling system is full of proper mixture of water and engine coolant before each heater use.
- Heater is designed for all-night operation; however, 2-5 hours of heating just prior to starting is usually sufficient for proper engine starting.
- When heater is in operation, unit must be parked in a level position to maintain the proper orientation of the heater.
- Use only an undamaged extension cord, outdoors rated, three-prong grounded 120VAC cord with a minimum amperage rating of 10A. Connect to properly grounded 120VAC, GFCI outlet only.
- Unplug extension cord from power first; then unplug heater cordset from extension cord before starting the engine.

GENERAL MAINTENANCE

Poorly maintained equipment can become a safety hazard! In order for the equipment to operate safely and properly over a long period of time, periodic maintenance and occasional repairs are necessary. **NEVER** perform even routine service (oil/filter changes, cleaning, etc.) unless all electrical components are shut down. When servicing this equipment always follow the instructions listed below.

- Before servicing this machine, make sure the control power switch is turned to OFF “O”.
- The circuit breakers are open (OFF “O”).
- The emergency stop switch is activated (pushed in).
- The negative (-) terminal on battery is disconnected.
- Attach a “DO NOT START” sign to the control panel. This will notify everyone that the unit is being serviced and will reduce the chance of someone inadvertently trying to start the unit.
- Never wash the unit with a high pressure hose or with any kind of power washer.
- Never wash the engine block or fuel tank with a power washer or steam cleaner. Water may enter the cabinet and collect in the generator windings or other electrical parts, causing damage.
- If the unit is stored outside, check for water inside the cabinet and generator and dry the unit thoroughly before starting.
- Inspect condition of electrical cords. **DO NOT** use unit if insulation is cut or worn through.
- Check the wheel lugs. Tighten or replace any that are loose or missing. If a tire has been removed for axle service or replaced, tighten the lugs in the order shown in [“Lifting The Trailer” on page 28](#).
- Check coolant levels. Refer to the engine operator’s manual when determining proper mixture.
 - Coolant is checked visually by inspecting the level in coolant overflow jug near the radiator.
 - Normal operation is between the “FULL” and “ADD” markings on the overflow jug, this is known as “Normal Range”.
 - Coolant may be added directly to jug **WHEN ENGINE IS STOPPED AND COMPLETELY COOL**.
- Check the oil levels. Refer to the engine operator’s manual when determining proper viscosity.
 - **DO NOT** start unit if engine oil level is below the “ADD” mark on the dipstick.
 - Normal operation is between the “FULL” and “ADD” markings on the dipstick.
 - Add oil only if oil level is below cross-hatch pattern on the dipstick. **DO NOT OVERFILL** crankcase.
- Check fuel level.

Note: *During the first 100 hours of operation, avoid long periods of no load or sustained maximum load operation. If the unit is to run for longer than five minutes without a load, shut the engine down.*

BASIC MAINTENANCE SCHEDULE (ISUZU ENGINE)

NOTICE

Refer to the original equipment manufacturer's operating manual for a complete list of maintenance requirements. Failure to comply with the procedures as described in the engine operator manual will nullify the warranty, decrease performance and cause equipment damage or premature equipment failure.

Use the schedule in the following table as a guide for regular maintenance intervals. For additional or replacement copies of the engine operator's manual, contact an authorized dealer in your area.

Item	Daily	250 Hours	500 Hours	1000 Hours
Check Oil Level	◆			
Check Coolant Level	◆			
Check Fuel Level	◆			
Drain Fuel Filter	◆			
Check Tire Pressure	◆			
Check All Electrical Connections	◆			
Clean Battery	◆			
Check Fan Belt Tension (Replace If Necessary)	◆			
Inspect Radiator Fins For Debris, Clean As Required	◆			
Preheating Condition Check	◆			
Check Engine Starting Conditions and Noise Conditions	◆			
Check Exhaust Smoke Condition	◆			
Replace Engine Oil		◆		
Replace Fuel Filter Element		◆		
Clean Water Sedimenter Element		◆		
Electromagnetic Pump Filter Replacement Or Cleaning		◆		
Check Fan Belt Tension (Replace If Necessary)			◆	
Oil Filter Element Replacement			◆	
Replace Air Filter Element			◆	
Lubricate Leveling Jacks			◆	
Replace Heated Fuel Filter (If Equipped)				◆
Inspect Engine Starting Battery				◆

AC WIRING DIAGRAM

Shown with receptacle panel part number 12398 (2x5-20R, 2xL6-30R, 2x50A).

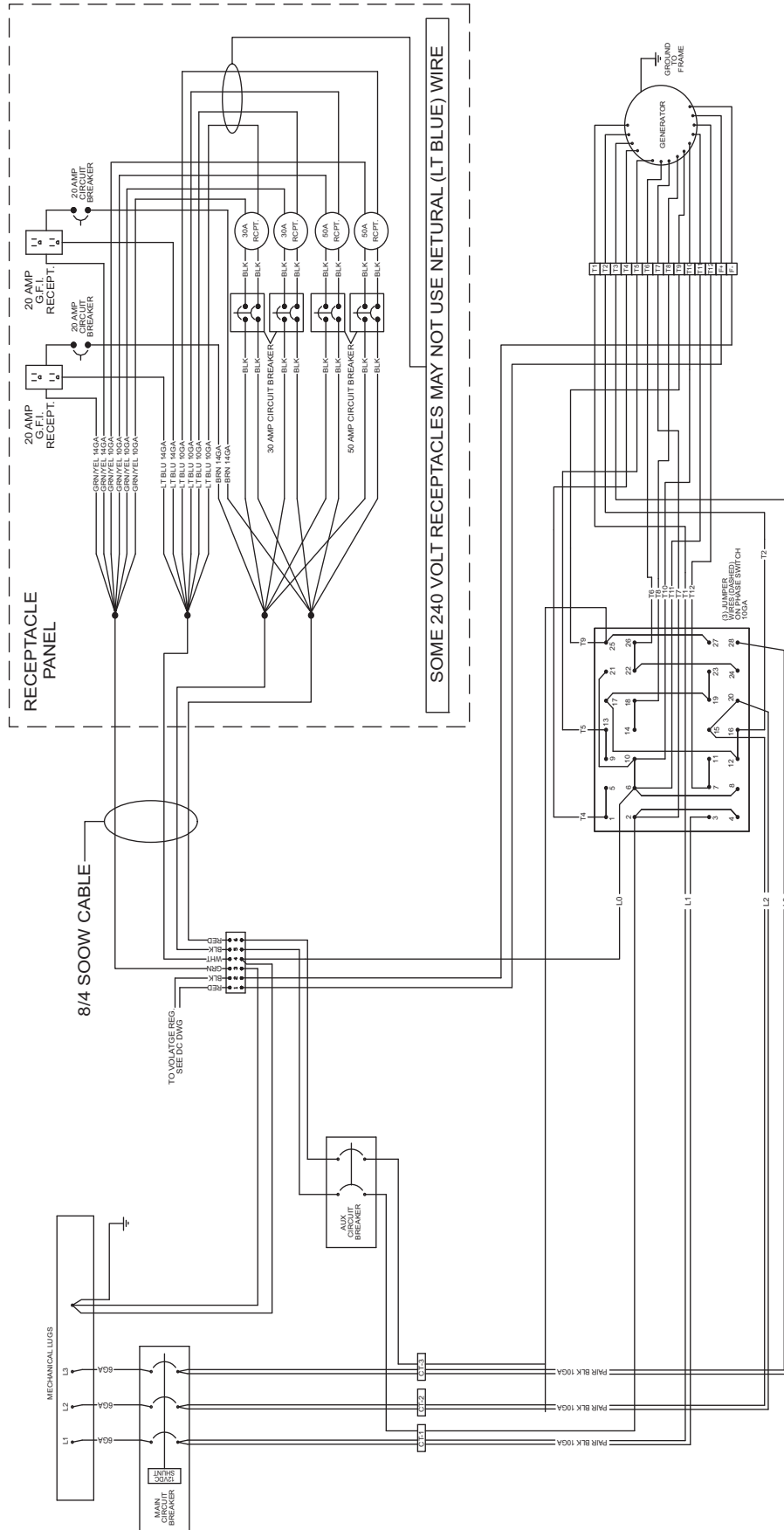

90326_ORG_05.05.03

AC WIRING RECEPTACLE PANEL OPTIONS

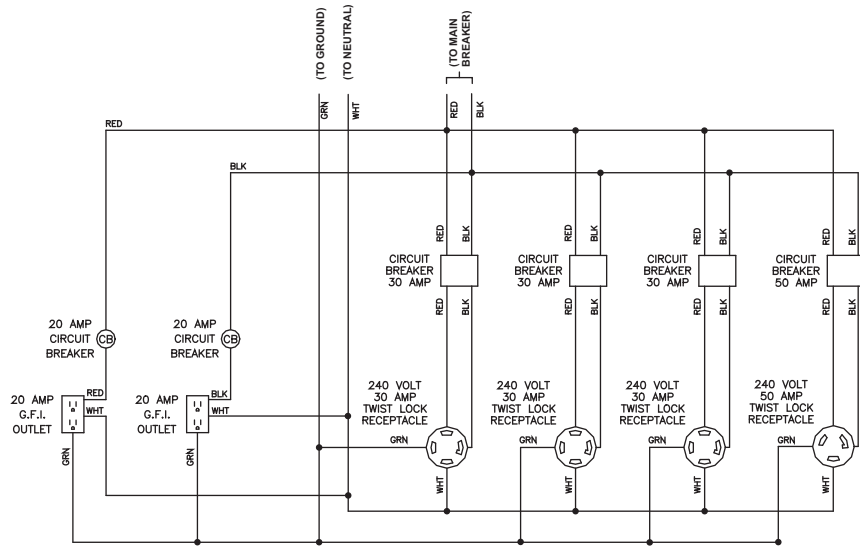

Receptacle Panel (2x5-20R, 3xL6-30R, 1x50A)

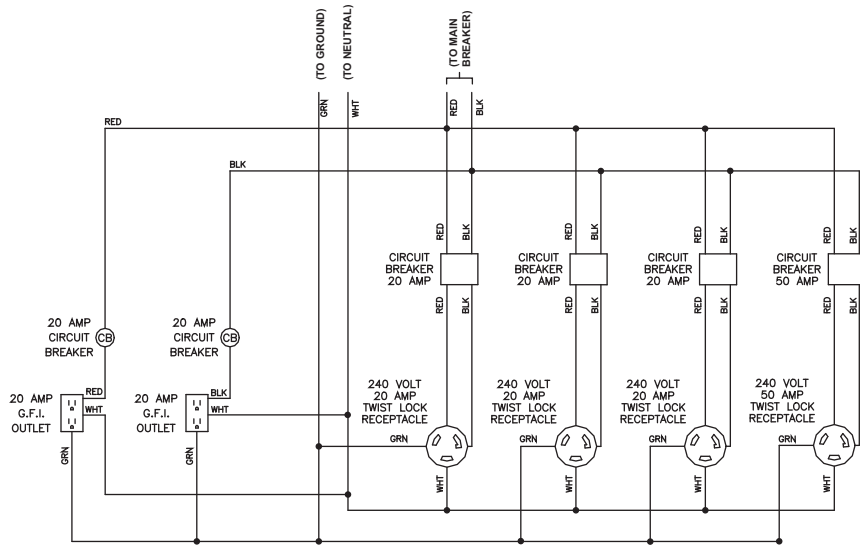

Receptacle Panel (2x5-20R, 3xL6-20R, 1x50A)

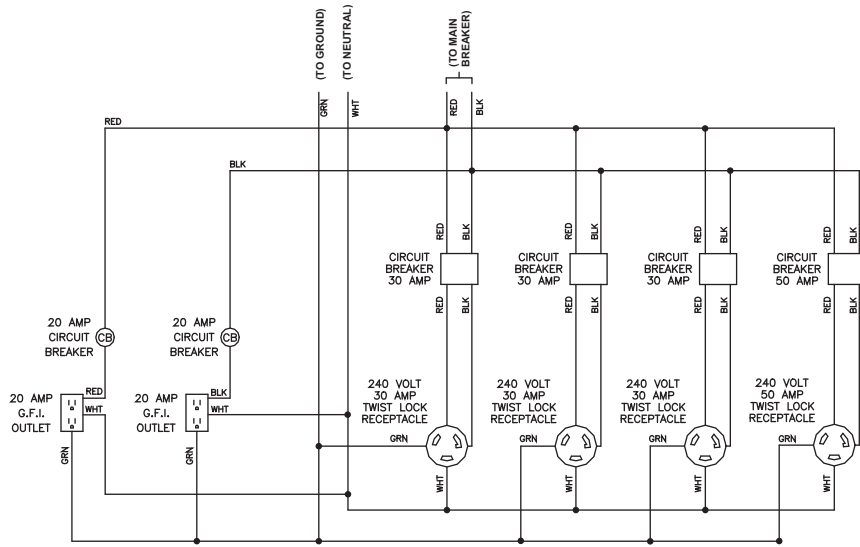

Receptacle Panel (2x5-20R, 3xL14-30R, 1x50A)

AC WIRING RECEPTACLE PANEL OPTIONS (CONTINUED)

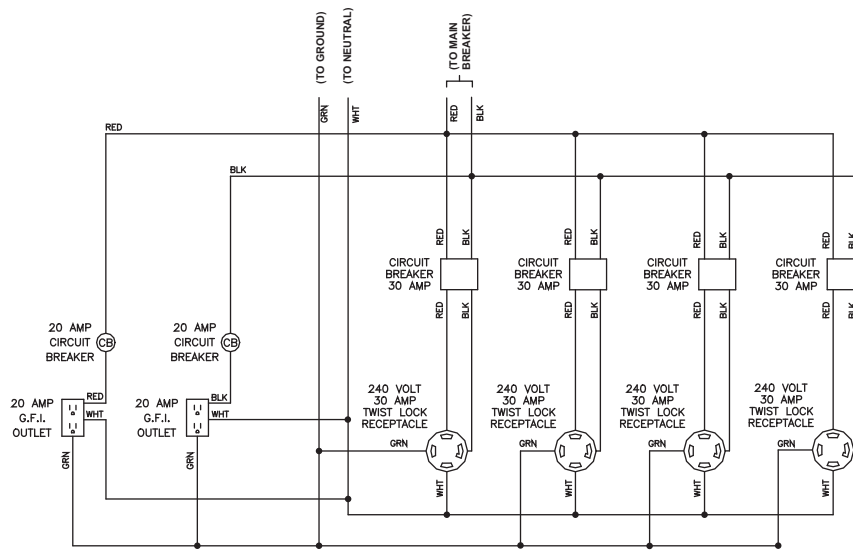

Receptacle Panel (2x5-20R, 4xL14-30R)

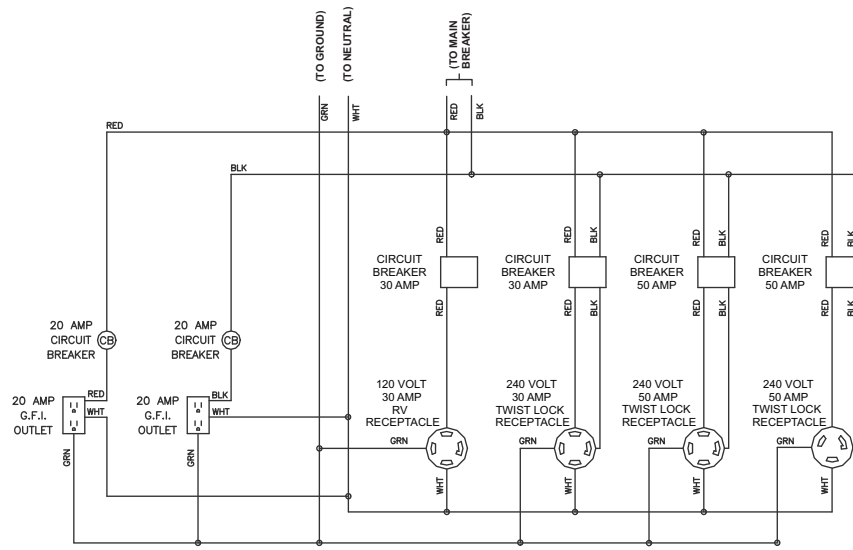

Receptacle Panel (2x5-20R, 1xTT-30R, 1xL6-30R, 2x50A)

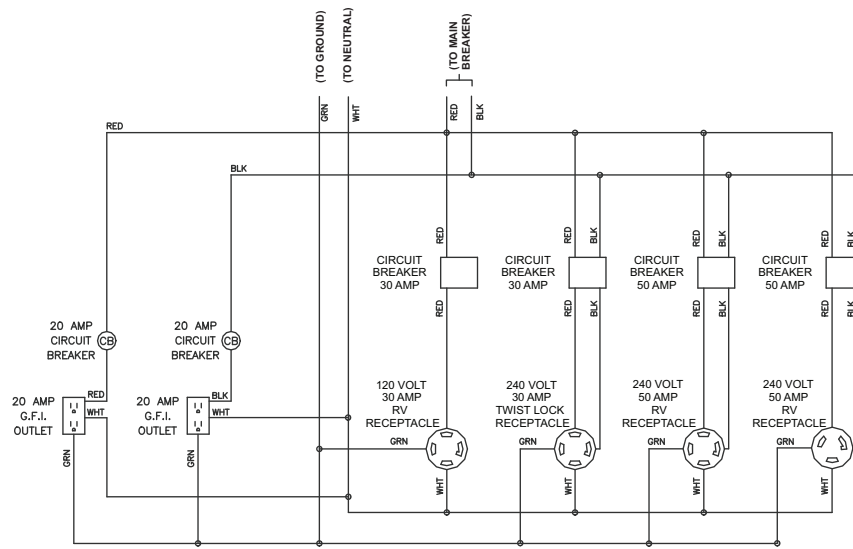

Receptacle Panel (2x5-20R, 2xTT-30R, 2x14-50)

DC WIRING DIAGRAM

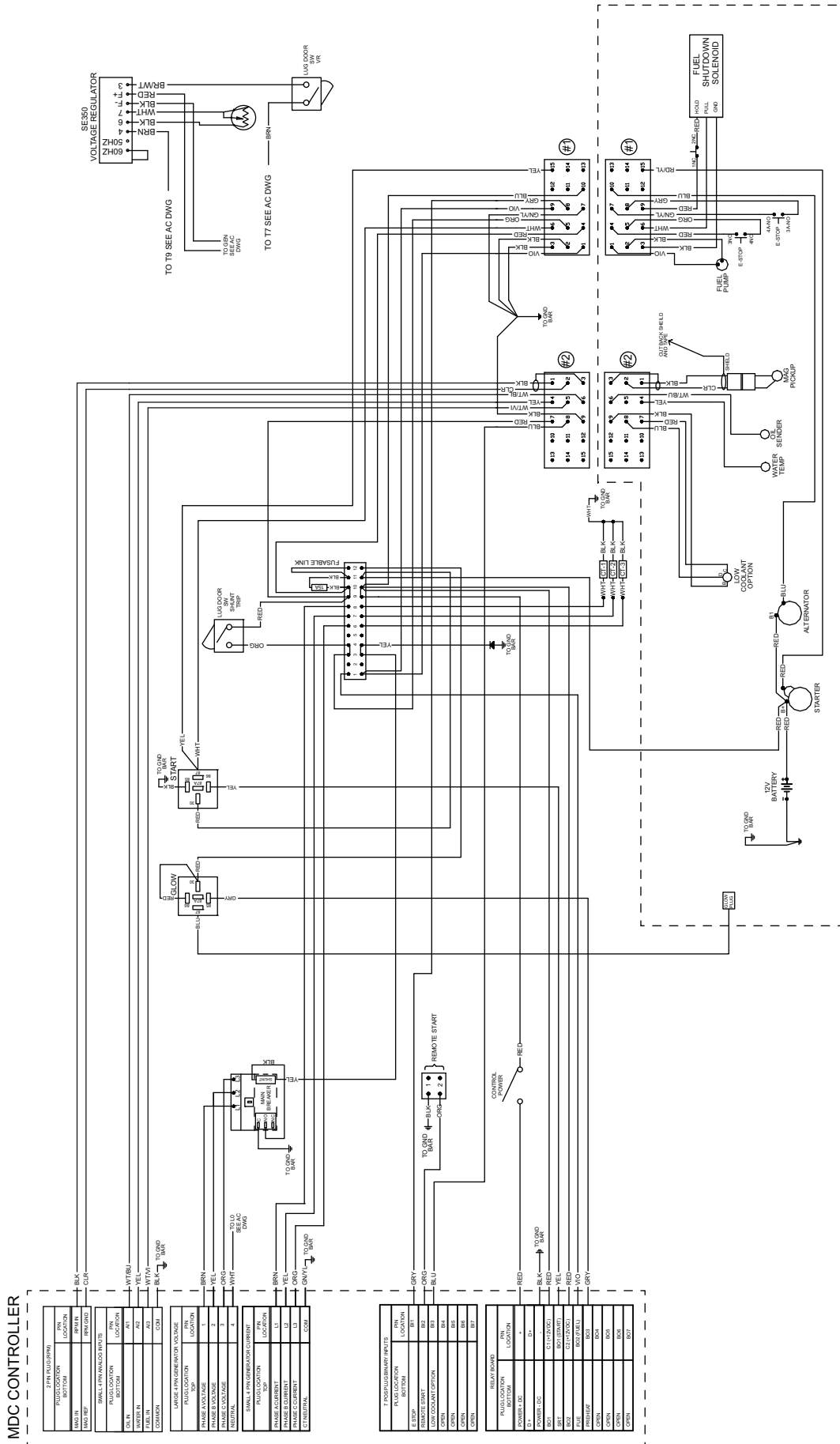

MDC CONTROLLER

3-14M (ALTERNATOR)	PN
FUSIBLE LINK	PN
IGNITION SWITCH	PN
IGNITION SWITCH	PN

3-14M (ALTERNATOR)	PN
FUSIBLE LINK	PN
IGNITION SWITCH	PN
IGNITION SWITCH	PN

3-14M (ALTERNATOR)	PN
FUSIBLE LINK	PN
IGNITION SWITCH	PN
IGNITION SWITCH	PN

3-14M (ALTERNATOR)	PN
FUSIBLE LINK	PN
IGNITION SWITCH	PN
IGNITION SWITCH	PN

3-14M (ALTERNATOR)	PN
FUSIBLE LINK	PN
IGNITION SWITCH	PN
IGNITION SWITCH	PN

3-14M (ALTERNATOR)	PN
FUSIBLE LINK	PN
IGNITION SWITCH	PN
IGNITION SWITCH	PN

3-14M (ALTERNATOR)	PN
FUSIBLE LINK	PN
IGNITION SWITCH	PN
IGNITION SWITCH	PN

3-14M (ALTERNATOR)	PN
FUSIBLE LINK	PN
IGNITION SWITCH	PN
IGNITION SWITCH	PN

3-14M (ALTERNATOR)	PN
FUSIBLE LINK	PN
IGNITION SWITCH	PN
IGNITION SWITCH	PN

3-14M (ALTERNATOR)	PN
FUSIBLE LINK	PN
IGNITION SWITCH	PN
IGNITION SWITCH	PN

3-14M (ALTERNATOR)	PN
FUSIBLE LINK	PN
IGNITION SWITCH	PN
IGNITION SWITCH	PN

3-14M (ALTERNATOR)	PN
FUSIBLE LINK	PN
IGNITION SWITCH	PN
IGNITION SWITCH	PN

3-14M (ALTERNATOR)	PN
FUSIBLE LINK	PN
IGNITION SWITCH	PN
IGNITION SWITCH	PN

3-14M (ALTERNATOR)	PN
FUSIBLE LINK	PN
IGNITION SWITCH	PN
IGNITION SWITCH	PN

3-14M (ALTERNATOR)	PN
FUSIBLE LINK	PN
IGNITION SWITCH	PN
IGNITION SWITCH	PN

3-14M (ALTERNATOR)	PN
FUSIBLE LINK	PN
IGNITION SWITCH	PN
IGNITION SWITCH	PN

3-14M (ALTERNATOR)	PN
FUSIBLE LINK	PN
IGNITION SWITCH	PN
IGNITION SWITCH	PN

3-14M (ALTERNATOR)	PN
FUSIBLE LINK	PN
IGNITION SWITCH	PN
IGNITION SWITCH	PN

905051_G_04.08.14

TRAILER LIGHTS WIRING DIAGRAM

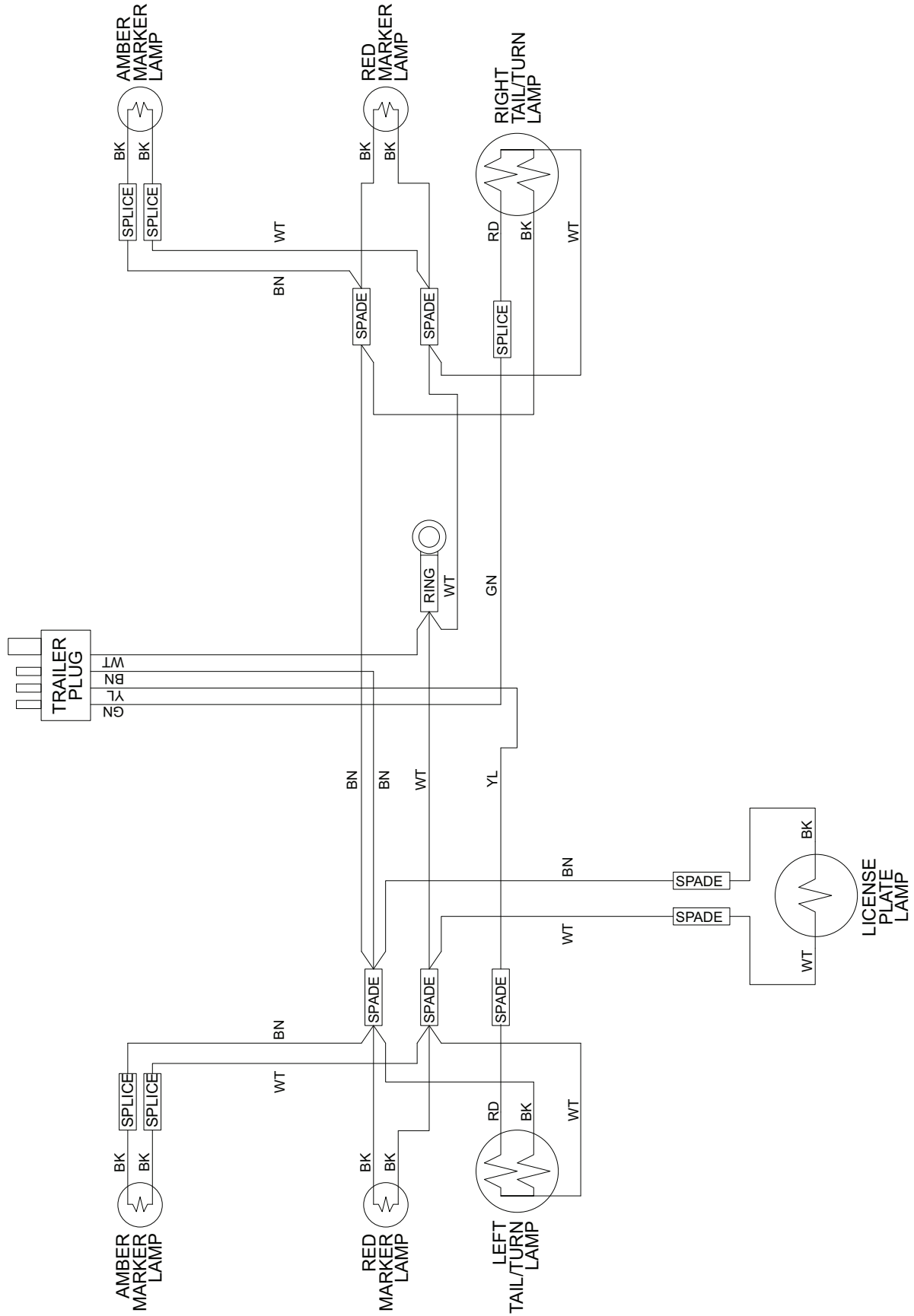

90341_B_12.20.13

REV: J
PART NO: 12346
07.01.14